

# Grandstream Networks, Inc.

---

## GWN76XX Wi-Fi Access Points

### User Manual



**GWN7630**  
Enterprise  
802.11ac Wave-  
2 4x4 Wi-Fi  
Access Point



**GWN7610**  
Enterprise  
802.11ac  
Wi-Fi  
Access Point



**GWN7600LR**  
Outdoor Long  
Range 802.11ac  
Wave-2 Wi-Fi  
Access Point



**GWN7615**  
Enterprise  
802.11ac Wave-2  
3x3:3 Wi-Fi  
Access Point



**GWN7605**  
Enterprise  
802.11ac Wave-  
2 2x2 Wi-Fi  
Access Point



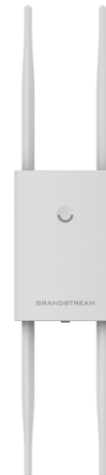
**GWN7605LR**  
Outdoor Long-  
Range 802.11ac  
Wave-2 2x2:2 Wi-Fi  
Access Point



**GWN7660**  
802.11ax  
2x2:2  
Wi-Fi 6  
Access Point



**GWN7600**  
Enterprise  
802.11ac  
Wave-2 Wi-Fi  
Access Point



**GWN7630LR**  
Outdoor Long  
Range 802.11ac  
Wave-2 4x4:4 Wi-Fi  
Access Point



## **COPYRIGHT**

©2021 Grandstream Networks, Inc. <https://www.grandstream.com>

All rights reserved. Information in this document is subject to change without notice. Reproduction or transmittal of the entire or any part, in any form or by any means, electronic or print, for any purpose without the express written permission of Grandstream Networks, Inc. is not permitted.

The latest electronic version of this guide is available for download here:

<https://www.grandstream.com/support>

Grandstream is a registered trademark and Grandstream logo is trademark of Grandstream Networks, Inc. in the United States, Europe and other countries.

## **CAUTION**

Changes or modifications to this product not expressly approved by Grandstream, or operation of this product in any way other than as detailed by this guide, could void your manufacturer warranty.

## **WARNING**

Please do not use a different power adaptor with devices as it may cause damage to the products and void the manufacturer warranty.



## FCC Caution

Any changes or modifications to this unit not expressly approved by the party responsible for compliance could void the user's authority to operate the equipment.

This device complies with 15 of the FCC Rules. Operation is subject to the following two conditions: (1) This device may not cause harmful interference, and (2) this device must accept any interference received, including interference that may cause undesired operation.

### Note:

This equipment has been tested and found to comply with the limits for a Class B digital device, pursuant to Part 15 of the FCC Rules. These limits are designed to provide reasonable protection against harmful interference in a residential installation. This equipment generates, uses, and can radiate radio frequency energy and, if not installed and used in accordance with the instructions, may cause harmful interference to radio communications. However, there is no guarantee that interference will not occur in a particular installation. If this equipment does cause harmful interference to radio or television reception, which can be determined by turning the equipment off and on, the user is encouraged to try to correct the interference by one or more of the following measures:

- Reorient or relocate the receiving antenna.
- Increase the separation between the equipment and receiver.
- Connect the equipment into an outlet on a circuit different from that to which the receiver is connected.
- Consult the dealer or an experienced radio/TV technician for help

This equipment complies with FCC radiation exposure limits set forth for an uncontrolled environment. This equipment should be installed and operated with minimum distance 20cm between the radiator & your body.

This transmitter must not be co-located or operating in conjunction with any other antenna transmitter.

## ISED Warning

This device complies with Innovation, Science, and Economic Development Canada licence-exempt RSS standard(s). Operation is subject to the following two conditions:

- (1) this device may not cause interference, and
- (2) this device must accept any interference, including interference that may cause undesired operation of the device.

Le présent appareil est conforme aux CNR d'Innovation, Sciences et Développement économique Canada applicables aux appareils radio exempts de licence. L'exploitation est autorisée aux deux conditions suivantes:



- (1) l'appareil ne doit pas produire de brouillage, et
- (2) l'utilisateur de l'appareil doit accepter tout brouillage radio électrique subi, même si le brouillage est susceptible d'en compromettre le fonctionnement.

## ISED Warning

This equipment complies with ISED radiation exposure limits set forth for an uncontrolled environment. This equipment should be installed and operated with minimum distance 20cm between the radiator & your body.

This transmitter must not be co-located or operating in conjunction with any other antenna or transmitter. Cet équipement est conforme aux ISED RF limites d'exposition aux radiations dans un environnement non contrôlé. Cet émetteur ne doit pas être situé ou opérant en conjonction avec une autre antenne ou émetteur.

## CE Authentication



BE	BG	CZ	DK	DE	EE	IE	EL
ES	FR	HR	IT	CY	LV	LT	LU
HU	MT	NL	AT	PL	PT	RO	SI
SK	FI	SE	NO	IS	LI	CH	TR

In all EU member states, operation of 5150-5350 MHz is restricted to indoor use only.

## EU Regulatory Information

GWN7630	GWN7630LR
<b>TX/RX Frequency</b>	<b>TX/RX Frequency</b>
<b>2.4G Wi-Fi:</b> 2412-2472MHz;	<b>2.4G Wi-Fi:</b> 2412-2472MHz;
<b>5G Wi-Fi:</b> 5150-5250MHz;5250-5350 MHz; 5470-5725 MHz	<b>5G Wi-Fi:</b> 5150-5250MHz;5250-5350 MHz; 5470-5725 MHz
<b>Output power</b>	<b>Output power</b>
WLAN 2.4G < 20dBm;	WLAN 2.4G < 20dBm;
WLAN 5150-5250MHz< 23dBm	WLAN 5150-5250MHz< 23dBm
WLAN 5250-5350 MHz< 20dBm	WLAN 5250-5350 MHz< 20dBm
WLAN 5470-5725 MHz< 27dBm	WLAN 5470-5725 MHz< 27dBm
<b>Modulation</b>	<b>Modulation</b>
DSSS, OFDM	DSSS, OFDM

<b>GWN7610</b>	<b>GWN7600</b>
<b>TX/RX Frequency</b>	<b>TX/RX Frequency</b>
<b>2.4G Wi-Fi:</b> 2412-2472MHz;	<b>2.4G Wi-Fi:</b> 2412-2472MHz;
<b>5G Wi-Fi:</b> 5150-5250MHz	<b>5G Wi-Fi:</b> 5150-5250MHz
<b>Output power</b>	<b>Output power</b>
WLAN 2.4G < 20dBm;	WLAN 2.4G < 20dBm;
WLAN 5150-5250MHz< 23dBm	WLAN 5150-5250MHz< 23dBm
<b>Modulation</b>	<b>Modulation</b>
DSSS, OFDM	DSSS, OFDM

<b>GWN7615</b>	<b>GWN7600LR</b>
<b>TX/RX Frequency</b>	<b>TX/RX Frequency</b>
<b>2.4G Wi-Fi:</b> 2412-2472MHz;	<b>2.4G Wi-Fi:</b> 2412-2472MHz;
<b>5G Wi-Fi:</b> 5150-5250MHz;5250-5350 MHz; 5470-5725 MHz	<b>5G Wi-Fi:</b> 5150-5250MHz;5250-5350 MHz; 5470-5725 MHz; 5725-5850MHz
<b>Output power</b>	<b>Output power</b>
WLAN 2.4G < 20dBm;	WLAN 2.4G < 20dBm;
WLAN 5150-5250MHz< 23dBm	WLAN 5150-5250MHz< 23dBm
WLAN 5250-5350 MHz< 20dBm	WLAN 5250-5350 MHz< 20dBm
WLAN 5470-5725 MHz< 27dBm	WLAN 5470-5725 MHz< 27dBm
	WLAN 5725-5850 MHz<14dBm
<b>Modulation</b>	<b>Modulation</b>
DSSS, OFDM	DSSS, OFDM

<b>GWN7605</b>	<b>GWN7605LR</b>
<b>TX/RX Frequency</b>	<b>TX/RX Frequency</b>
<b>2.4G Wi-Fi:</b> 2412-2472MHz;	<b>2.4G Wi-Fi:</b> 2412-2472MHz;
<b>5G Wi-Fi:</b> 5150-5250MHz;5250-5350 MHz; 5470-5725 MHz	<b>5G Wi-Fi:</b> 5150-5250MHz;5250-5350 MHz; 5470-5725 MHz
<b>Output power</b>	<b>Output power</b>
WLAN 2.4G < 20dBm;	WLAN 2.4G < 20dBm;



WLAN 5150-5250MHz< 23dBm	WLAN 5150-5250MHz< 23dBm
WLAN 5250-5350 MHz< 20dBm	WLAN 5250-5350 MHz< 20dBm
WLAN 5470-5725 MHz< 27dBm	WLAN 5470-5725 MHz< 27dBm
<b>Modulation</b>	<b>Modulation</b>
DSSS, OFDM	DSSS, OFDM

<b>GWN7660</b>
<b>TX/RX Frequency</b>
<b>2.4G Wi-Fi:</b> 2412-2472MHz;
<b>5G Wi-Fi:</b> 5150-5250MHz;5250-5350 MHz; 5470-5725 MHz
<b>Output power</b>
WLAN 2.4G < 20dBm;
WLAN 5150-5250MHz< 23dBm
WLAN 5250-5350 MHz< 20dBm
WLAN 5470-5725 MHz< 27dBm
<b>Modulation</b>
DSSS, OFDM

The simplified EU declaration of conformity referred to in Article 10(9) shall be provided as follows:  
 Hereby, [Grandstream Networks, Inc.] declares that the radio equipment type [GWN/7660/GWN7630/GWN7630LR/GWN7610/GWN7600/GWN7600LR/GWN7605/GWN7605LR/GWN7615] are in compliance with Directive 2014/53/EU.

The full text of the EU declaration of conformity is available at the following internet address:  
[www.grandstream.com](http://www.grandstream.com)

## GNU GPL INFORMATION

GWN76XX firmware contains third-party software licensed under the GNU General Public License (GPL).

Grandstream uses software under the specific terms of the GPL. Please see the GNU General Public License (GPL) for the exact terms and conditions of the license.

Grandstream GNU GPL related source code can be downloaded from Grandstream web site:

<https://www.grandstream.com/support/faq/gnu-general-public-license>



## Table of Contents

<b>DOCUMENT PURPOSE .....</b>	<b>17</b>
<b>CHANGE LOG .....</b>	<b>18</b>
Firmware Version 1.0.19.32 .....	18
Firmware Version 1.0.19.14 .....	18
Firmware Version 1.0.19.29 .....	18
Firmware Version 1.0.19.25 .....	18
Firmware Version 1.0.19.23 .....	18
Firmware Version 1.0.19.22 .....	18
Firmware Version 1.0.19.15 .....	19
Firmware Version 1.0.19.9 .....	19
Firmware Version 1.0.15.20 .....	19
Firmware Version 1.0.15.18 .....	19
Firmware Version 1.0.15.5 .....	19
Firmware Version 1.0.15.4 .....	19
Firmware Version 1.0.15.6 .....	20
Firmware Version 1.0.11.10 .....	20
Firmware Version 1.0.11.8 .....	20
Firmware Version 1.0.8.18 .....	20
Firmware Version 1.0.8.9 .....	20
Firmware Version 1.0.7.13 .....	20
Firmware Version 1.0.4.22 .....	21
Firmware Version 1.0.4.20 .....	21
Firmware Version 1.0.4.12 .....	21
Firmware Version 1.0.3.25 .....	21
Firmware Version 1.0.3.21 .....	21
Firmware Version 1.0.3.19 .....	21
Firmware Version 1.0.2.108 .....	22
Firmware Version 1.0.2.15 .....	22





Firmware Version 1.0.1.31 .....	22
Firmware Version 1.0.1.27 .....	22
<b>WELCOME .....</b>	<b>23</b>
<b>PRODUCT OVERVIEW .....</b>	<b>25</b>
Technical Specifications.....	25
<b>INSTALLATION .....</b>	<b>40</b>
Equipment Packaging.....	40
GWN76XX Access Point Ports .....	42
Power and Connect GWN76XX Access Point.....	43
Warranty.....	44
Wall/Ceiling Mount Installation GWN76XX .....	44
<i>Wall Mount</i> .....	44
<i>Ceiling Mount</i> .....	45
Mounting Instructions for GWN7600LR.....	46
Mounting Instructions for GWN7630LR/GWN7605LR .....	47
<i>Wall Mount</i> .....	47
<i>Pole Mount</i> .....	48
<b>GETTING STARTED.....</b>	<b>49</b>
LED Patterns.....	49
Discover the GWN76XX .....	50
<i>Method 1: Discover the GWN76XX using its MAC address</i> .....	50
<i>Method 2: Discover the GWN76XX using GWN Discovery Tool</i> .....	51
Use the Web GUI.....	51
<i>Access Web GUI</i> .....	52
<i>WEB GUI Languages</i> .....	52
<i>Overview Page</i> .....	53
<i>Save and Apply Changes</i> .....	54
<b>GWN MANAGEMENT PLATFORMS .....</b>	<b>55</b>
GWN.Cloud.....	55



GWN.Manager .....	55
<b>USING GWN76XX AS STANDALONE ACCESS POINT .....</b>	<b>56</b>
Connect to GWN76XX Default Wi-Fi Network.....	56
<b>USING GWN76XX AS MASTER ACCESS POINT CONTROLLER .....</b>	<b>57</b>
Login Page .....	58
Discover and Pair Other GWN76XX Access Point .....	58
AP Location.....	62
Transfer AP – Transfer Network Group.....	62
Failover Master .....	62
<i>Failover Mode</i> .....	63
Takeover Feature .....	64
Transfer to Master.....	66
Client Bridge .....	67
<b>ACCESS POINTS .....</b>	<b>69</b>
Status .....	69
Configuration.....	71
<i>Add New Access Points</i> .....	71
<i>Move Access Points</i> .....	72
<i>Delete Access Points</i> .....	72
<i>Reboot Access Points</i> .....	72
<i>Configure Access Points</i> .....	72
<i>Reset Access Points</i> .....	75
<b>SSIDs.....</b>	<b>76</b>
<b>CLIENTS .....</b>	<b>83</b>
Clients .....	83
<b>ACCESS CONTROL.....</b>	<b>85</b>
Access List.....	85
Time Policy.....	86
<i>Banned Clients</i> .....	87



Bandwidth Rules.....	88
<b>CAPTIVE PORTAL .....</b>	<b>90</b>
Guest.....	90
Policy List.....	91
<i>Internal Splash Page</i> .....	92
<i>External Splash Page</i> .....	95
Splash Page.....	96
Vouchers .....	97
<i>Voucher Feature Description</i> .....	97
<i>Voucher Configuration</i> .....	98
<i>Using Voucher with GWN Captive Portal</i> .....	100
<b>RADIO.....</b>	<b>102</b>
<b>SECURITY .....</b>	<b>106</b>
Rogue AP .....	106
Firewall.....	108
<b>SERVICE .....</b>	<b>110</b>
Hotspot 2.0.....	110
SNMP.....	113
DHCP Server .....	114
<i>NAT Pool</i> .....	114
<i>Static DHCP</i> .....	115
<b>SYSTEM .....</b>	<b>116</b>
Settings .....	116
<i>LEDs</i> .....	116
<i>Basic</i> .....	116
<i>Account</i> .....	118
Mesh .....	118
Schedule .....	121
Maintenance .....	122



<i>Upgrade</i> .....	122
<i>Syslog</i> .....	124
Alert.....	124
<i>Email</i> .....	124
<i>Alert Configure</i> .....	124
<b>UPGRADING AND PROVISIONING .....</b>	<b>126</b>
Upgrading Firmware .....	126
<i>Upgrading via Web GUI</i> .....	126
Upgrading Slave Access Points.....	127
<i>Sequential Upgrade</i> .....	128
Provisioning and Backup .....	129
<i>Download Configuration</i> .....	129
<i>Upload Configuration</i> .....	129
<i>Configuration Server</i> .....	130
Reset and reboot .....	130
Syslog .....	130
<b>EXPERIENCING THE GWN76XX Wi-Fi ACCESS POINTS.....</b>	<b>131</b>



## Table of Tables

Table 1: GWN7660 Technical Specifications .....	25
Table 2: GWN7630 Technical Specifications .....	26
Table 3: GWN7615 Technical Specifications .....	28
Table 4: GWN7610 Technical Specifications .....	30
Table 5: GWN7605 Technical Specifications .....	31
Table 6: GWN7605LR Technical Specifications .....	33
Table 7: GWN7600 Technical Specifications .....	35
Table 8: GWN7600LR Technical Specifications .....	36
Table 9: GWN7630LR Technical Specifications .....	38
Table 10: GWN7660/GWN7630/GWN7610/GWN7615/GWN7605/GWN7600 Equipment Packaging ....	40
Table 11: GWN7600LR Equipment Packaging .....	41
Table 12: GWN7630LR Equipment Packaging .....	42
Table 13: GWN76XX AP Ports Description .....	43
Table 14: LED Patterns .....	49
Table 15: Overview .....	53
Table 16: Device Configuration .....	60
Table 17: Access Points Status Parameters .....	69
Table 18: Access Point Configuration Settings .....	73
Table 19: Wi-Fi .....	76
Table 20: Time Policy Parameters .....	87
Table 21: Bandwidth Rules .....	88
Table 22: Captive Portal – Policy List – Splash Page is “Internal” .....	92
Table 23: Captive Portal – Policy List – Splash Page is “External” .....	95
Table 24: Voucher Parameters .....	99
Table 25: Radio Settings .....	103
Table 26: Rogue AP .....	107
Table 27: Firewall- Outbound .....	108
Table 28: Firewall-Inbound .....	109
Table 29: Hotspot 2.0 .....	110
Table 30: SNMP .....	113
Table 31: DHCP Server Parameters .....	114
Table 32: NAT Pool Parameters .....	115
Table 33: LEDs .....	116
Table 34: Basic .....	116
Table 35: DFS Channels supported by Model .....	117
Table 36: Account .....	118
Table 37: Mesh configuration on GWN76XX .....	120
Table 38: Upgrade .....	122
Table 39: Syslog Parameters .....	124



Table 40: Email configuration .....	124
Table 41: Email Events.....	125
Table 42: Network Upgrade Configuration .....	126

## Table of Figures

Figure 1: GWN7660/GWN7630/GWN7610/GWN7605/GWN7600 Equipment Packaging .....	40
Figure 2: GWN7600LR Equipment Package .....	41
Figure 3: GWN7630LR/GWN7605LR Equipment Package.....	42
Figure 4: GWN7660/GWN7630/GWN7615 .....	42
Figure 5: GWN7610/GWN7600 Ports.....	42
Figure 6: GWN7600LR Ports .....	42
Figure 7: GWN7630LR.....	42
Figure 8: Connecting GWN AP - GWN7600 as example.....	44
Figure 9: Wall Mount – Steps 1 & 2 .....	44
Figure 10: Wall Mount – Steps 3 & 4 .....	44
Figure 11: Wall Mount – Steps 5 & 6.....	45
Figure 12: Ceiling Mount – Steps 1 & 2 .....	45
Figure 13: Ceiling Mount – Step 3 .....	45
Figure 14: Ceiling Mount – Step 4 .....	45
Figure 15: Ceiling Mount – Steps 5 & 6 .....	46
Figure 16: GWN7600LR Vertical Mounting.....	46
Figure 17: GWN7600LR Horizontal Mounting .....	47
Figure 18: GWN7630LR/GWN7605LR Mounting Instructions.....	47
Figure 19: GWN7630LR/GWN7605LR Wall Mount.....	47
Figure 20: GWN7630LR/GWN7605LR Pole Mount.....	48
Figure 21: Discover the GWN76XX using its MAC Address.....	50
Figure 22: GWN Discovery Tool.....	51
Figure 23: GWN76XX Web GUI Login Page .....	52
Figure 24: GWN76XX Web GUI Language (Login page) .....	52
Figure 25: GWN76XX Web GUI Language (Web Interface).....	53
Figure 26: GWN76XX Dashboard (GWN7600 as example).....	53
Figure 27: Apply Changes.....	54
Figure 28: GWN.Cloud Architecture.....	55
Figure 29: GWN Manager Architecture.....	55
Figure 30: MAC Tag Label .....	56
Figure 31: Login Page.....	57
Figure 32: Setup Wizard .....	58
Figure 33: Option 43 Override .....	59



Figure 34: Discover and Pair GWN76XX.....	59
Figure 35: Discovered Devices .....	59
Figure 36: GWN76XX Online .....	60
Figure 37: Failover Master .....	63
Figure 38: Failover Mode GUI.....	64
Figure 39: Takeover - Step 1.....	65
Figure 40: Takeover - Step 2.....	65
Figure 41: Takeover - Step 3.....	66
Figure 42: Switch to Master .....	66
Figure 43: Transfer Master Role to another device confirmation message .....	67
Figure 44: Then new assigned Master AP web interface.....	67
Figure 45: Client Bridge .....	68
Figure 46: Client Bridge .....	68
Figure 47: Client Bridge Mode .....	68
Figure 48: Access Points - Status .....	69
Figure 49: AP Info .....	70
Figure 50: Current Clients - Stats per AP.....	70
Figure 51: Debug Tool Tab .....	71
Figure 52: Access Points Configuration Page.....	71
Figure 53: Moving Access Points between Networks .....	72
Figure 54: Delete Access Point.....	72
Figure 55: Reboot Access Point.....	72
Figure 56: Access Point Configuration Page .....	73
Figure 57: Reset Access Point .....	75
Figure 58: SSIDs.....	76
Figure 59: Add a new SSID.....	76
Figure 60: Device Membership .....	82
Figure 61: Clients .....	83
Figure 62: Clients - Select Items .....	84
Figure 63: Global Blacklist .....	85
Figure 64: Managing the Global Blacklist .....	85
Figure 65: Adding Client Access List.....	85
Figure 66: Adding New Access List.....	86
Figure 67: Blacklist Access List.....	86
Figure 68: Ban/Unban Client.....	87
Figure 69: MAC Address Bandwidth Rule.....	89
Figure 70: Bandwidth Rules .....	89
Figure 71: Captive Portal – Guest Page .....	90
Figure 72: Captive Portal - Guest Page - Select Items.....	90
Figure 73: Captive Portal - Policy List.....	91
Figure 74: Add a New Policy.....	92
Figure 75: Authentication rules .....	96



Figure 76: Captive Portal – Splash Page.....	97
Figure 77: Add Voucher Sample .....	99
Figure 78: Vouchers List .....	99
Figure 79: Captive Portal with Voucher authentication .....	101
Figure 80: Radio-General.....	102
Figure 81: Rogue AP-Configuration .....	106
Figure 82: Rogue AP-Detection .....	106
Figure 83: Firewall-Outbound .....	108
Figure 84: Firewall-inbound.....	108
Figure 85: Hotspot 2.0.....	110
Figure 86: SNMP.....	113
Figure 87: DHCP Binding.....	115
Figure 88: LED Scheduling Sample.....	116
Figure 89: Access Points Status .....	119
Figure 90: Mesh settings for GWN76XX.....	120
Figure 91: Create New Schedule .....	121
Figure 92: Schedules List.....	122
Figure 93: Alert Configure .....	124
Figure 94: Access Points.....	128
Figure 95: Choosing multiple devices .....	128
Figure 96: All-at-Once and Sequential Upgrade .....	129





## DOCUMENT PURPOSE

This document describes how to configure the GWN76XX via Web GUI in standalone mode, with other GWN76XX Access Points as Master/Slave architecture and more. The intended audiences of this document are network administrators. Please visit <http://www.grandstream.com/support> to download the latest “GWN76XX User Manual”.

This guide covers following topics:

- [Product Overview](#)
- [Installation](#)
- [Getting Started](#)
- [GWN Management Platforms](#)
- [Using GWN76XX as Standalone Access Point](#)
- [Using GWN76XX as Master Access Point Controller](#)
- [Failover Master](#)
- [Client Bridge](#)
- [SSIDs](#)
- [Clients Configuration](#)
- [System Settings](#)
- [LED Schedule](#)
- [Captive Portal](#)
- [Vouchers](#)
- [Mesh Network](#)
- [Bandwidth Rules](#)
- [DHCP Server](#)
- [Schedule](#)
- [LED Schedule](#)
- [Maintenance](#)
- [Upgrading and Provisioning](#)
- [Experiencing the GWN76XX Wireless Access Point](#)



## CHANGE LOG

This section documents significant changes from previous versions of the GWN76XX user manuals. Only major new features or major document updates are listed here. Minor updates for corrections or editing are not documented here.

### **Firmware Version 1.0.19.32**

**Product Name: GWN7630 / GWN7630LR / GWN7605 / GWN7605LR / GWN7615 / GWN7602 / GWN7600 / GWN7600LR / GWN7610**

- No major changes.

### **Firmware Version 1.0.19.14**

**Product Name: GWN7660**

- This is the initial version for GWN7660

### **Firmware Version 1.0.19.29**

**Product Name: GWN7630 / GWN7630LR / GWN7605 / GWN7605LR / GWN7615**

- No major changes

### **Firmware Version 1.0.19.25**

- No major changes

### **Firmware Version 1.0.19.23**

**Product Name: GWN7610 / GWN7600 / GWN7600LR**

- Added support for Secondary RADIUS Server. [Secondary RADIUS Server]
- Added support for Rogue AP Alert. [Alert Configure]

### **Firmware Version 1.0.19.22**

**Product Name: GWN7615 / GWN7602 / GWN7605 / GWN7605LR / GWN7630 / GWN7630LR**

- Added support for WPA3 (GWN7602 does NOT support). [Security Mode]
- Added support for Secondary RADIUS Server. [Secondary RADIUS Server]
- Added support for Rogue AP Alert. [Alert Configure]
- Added support of NET port VLAN settings. [Net Port Type]



## Firmware Version 1.0.19.15

- No major changes

## Firmware Version 1.0.19.9

- Added support of Rogue AP Detection. [Rogue AP]
- Added support of 802.11w. [802.11w]
- Added support of AutoTX Power. [RADIO]
- Added Captive Portal Enhancement. [CAPTIVE PORTAL]
- Added support of SNMP. [SNMP]
- Added support of more DFS Channels. [Scene]
- Added support of NAT. [NAT]
- Added support of Firewall. [Firewall]
- Added support of Hotspot 2.0 Beta. [Hotspot 2.0]
- Added support of Multicast/Broadcast Suppression. [Multicast/Broadcast Suppression]
- Extended support of RRM to GWN Cloud and remaining AP models. [Transmit Power Control][Coverage Hole Detection][Dynamic Channel Assignment]
- Added support of Active IGMP for feature Convert IP multicast to unicast enhancement. [Convert IP multicast to unicast]
  
- Allow DHCP Option43 to override GWN Manager Address. [Allow DHCP Option 43 to override GWN Manager Address]

## Firmware Version 1.0.15.20

**Product Name: GWN7610 / GWN7600 / GWN7600LR / GWN7630 / GWN7630LR**

- Added support for more DFS channels [Scene]

## Firmware Version 1.0.15.18

**Product Name: GWN7605**

- Added support for CE/RCM DFS channels [Scene]

## Firmware Version 1.0.15.5

**Product Name: GWN7605**

- This is the initial version for GWN7605

## Firmware Version 1.0.15.4

**Product Name: GWN7610 / GWN7600 / GWN7600LR/ GWN7630 / GWN7630LR**



- Added support of GWM Manager. [GWN Manager]
- Added LED pattern of yellow to indicate Mesh disconnection. [LED Patterns]
- Upgraded TLS to version 1.2.

## **Firmware Version 1.0.15.6**

**Product Name: GWN7630 / GWN7630LR**

- Added support for FCC DFS channels on GWN7630/GWN7630LR. [Scene]

## **Firmware Version 1.0.11.10**

**Product Name: GWN7630LR**

- This is the initial version for GWN7630LR.

## **Firmware Version 1.0.11.8**

**Product Name: GWN7610 / GWN7600 / GWN7600LR / GWN7630**

- Added support of DFS channel in EU for GWN7630. [Scene]
- Added support for Client Steering. [Client Steering]
- Added support for Minimum Rate Control. [RADIO]
- Added support for batch operations for Takeover. [Takeover Feature]
- Added support for Client inactivity timeout. [SSID]
- Enhanced Voucher feature by displaying remaining bytes. [Vouchers]
- Changed LED Pattern. [LED Patterns]
- Changed Local Master External Portal Configuration. [External Splash Page]
- Changed default setting of Mesh to OFF. [Mesh]

## **Firmware Version 1.0.8.18**

**Product Name: GWN7610 / GWN7600 / GWN7600LR**

- Added support of ARP Proxy. [ARP Proxy]
- Enhanced Bandwidth Rules by adding option to limit bandwidth Per-User. [Range Constraint]

## **Firmware Version 1.0.8.9**

**Product Name: GWN7610 / GWN7600 / GWN7600LR**

- No major changes

## **Firmware Version 1.0.7.13**

**Product Name: GWN7610 / GWN7600 / GWN7600LR**



- Added support of Radio Resource Management (RRM). [Dynamic Channel Assignment] [Transmit Power Control] [Coverage Hole Detection]

## **Firmware Version 1.0.4.22**

### **Product Name: GWN7610**

- Included patch for WPA2 4-way handshake vulnerability [VU#228519]

## **Firmware Version 1.0.4.20**

### **Product Name: GWN7610**

- Added support for Timed Client Disconnect and Enhanced Client Blocking [CLIENTS]
- Added support for Client Bridge [Client Bridge]
- Added support for Syslog server [Syslog]
- Added support for Configurable Web UI access port [Web HTTP Access]
- Added support for E-mail notifications [Email]

## **Firmware Version 1.0.4.12**

### **Product Name: GWN7600 / GWN7600LR**

- Added support for Timed Client Disconnect and Enhanced Client Blocking [CLIENTS]
- Added support for Client Bridge [Client Bridge]
- Added support for Syslog server [Syslog]
- Added support for Configurable Web UI access port [Web HTTP Access]
- Included patch for WPA2 4-way handshake vulnerability [VU#228519]

## **Firmware Version 1.0.3.25**

### **Product Name: GWN7600 / GWN7600LR**

- No major changes.

## **Firmware Version 1.0.3.21**

### **Product Name: GWN7610**

- No major changes.

## **Firmware Version 1.0.3.19**

### **Product Name: GWN7610 / GWN7600 / GWN7600LR**

- Added support for captive portal [CAPTIVE PORTAL]



- Added support for 802.11k/r/v [Enable Voice Enterprise]
- Added support for failover master [Failover Master]
- Added support for VLAN assignment via RADIUS [SSID][Enable Dynamic VLAN (beta)]
- Added support for Select SSID Band [SSID Band]
- Added support for Exact Radio Power Configuration in dBm [Custom Wireless Power]
- Added support for AP Location [AP Location]
- Added support for Per-Client/Per-SSID bandwidth rules [Bandwidth R]
- Added support for Wi-Fi Schedule [S]
- Added support for LED control [L]
- Added option to enable/disable DHCP option 66 & 43 override [Allow DHCP options 66 and 43 override]

## **Firmware Version 1.0.2.108**

### **Product Name: GWN7610**

- Added Controller protocol security enhancement. [Controller Protocol Security Enhancement]
- Added support for LED control. [L]
- Added support for Captive Portal. [CAPTIVE PORTAL]
- Added support for Wi-Fi schedule. [S]
- Added Client Isolation enhancement. [SSID]
- Added support to store Syslog locally on the unit and display it on Web GUI. [Syslog]

## **Firmware Version 1.0.2.15**

### **Product Name: GWN7610**

- Added New Overview Page.
- Added Web UI enhancement.
- Added support for Password change on first boot.
- Added Country code selection into setup wizard.

## **Firmware Version 1.0.1.31**

### **Product Name: GWN7600 / GWN7600LR**

- This is the initial version.

## **Firmware Version 1.0.1.27**

### **Product Name: GWN7610**

- This is the initial version.



## WELCOME

Thank you for purchasing Grandstream GWN76XX Enterprise Wireless Access Point.

The GWN7630/ GWN7610/GWN7610 are high-performance 802.11ac Wi-Fi access points for small to medium sized businesses, multiple floor offices, commercial locations and branch offices. GWN7630 and GWN7615/GWN7610 offers respectively a dual-band 4x4:4 MIMO and a 3x3:3 MIMO technology and a sophisticated antenna design for maximum network throughput and expanded Wi-Fi coverage range. To ensure easy installation and management, the GWN7630/GWN7615/GWN7610 uses a controller-less distributed network management design in which the controller is embedded within the product's Web user interface. This allows each access point to manage a network of up to 50 GWN76XX independently without needing separate controller hardware/software and without a single point-of-failure.

The GWN7600 is a mid-tier Wave-2 802.11ac Wi-Fi access point for small to medium sized businesses, multiple floor offices, commercial locations and branch offices. The GWN7600LR Outdoor Long-range 802.11ac Wave-2 Wi-Fi Access Point is designed to provide extended coverage support. Ideal for outdoor Wi-Fi solutions thanks to its waterproof casing and heat resistant technology. The GWN7600/GWN7600LR come equipped with dual-band, 2x2:2 MU-MIMO with beam-forming technology and a sophisticated antenna design for maximum network throughput and expanded Wi-Fi coverage range for both Indoor (GWN7600) and Outdoor deployment (GWN7600LR).

To ensure easy installation and management, the GWN7600/GWN7600LR uses a controller-less distributed network management design in which the controller is embedded within the product's web user interface. This allows each access point to manage a network of up to 30 GWN76XX series APs independently without needing separate controller hardware/software and without a single point-of-failure. This wireless access point can be paired with any third-party routers as well as Grandstream GWN series routers. With support for advanced QoS, low-latency real-time applications, 450+ concurrent client devices per AP and dual Gigabit network ports with PoE, the GWN7600/GWN7600LR is an ideal Wi-Fi access point for medium wireless network deployments with medium-to-high user density.

The GWN7630LR is an outdoor long-range Wi-Fi access point for medium to large businesses and enterprises who need to provide long-range coverage in both indoor and outdoor spaces. It offers weatherproof casing and heat resistant technology, dual-band 4x4:4 MU-MIMO technology, and a sophisticated antenna design for maximum network throughput that supports 200+ clients and an expanded 300-meter coverage range. the GWN7630LR is an ideal outdoor Wi-Fi access point for enterprises, multiple floor offices, warehouses, hospitals, schools and more.



The GWN7605/GWN7605LR is a high-performance-to-price 802.11ac Wave-2 Wi-Fi access point for small to medium sized businesses, multiple floor offices, commercial locations and branch offices. It offers dual-band 2x2:2 MU-MIMO with beam-forming technology and a sophisticated antenna design for maximum network throughput and expanded Wi-Fi coverage range. To ensure easy installation and management, the GWN7605/GWN7605LR uses a controller-less distributed network management design in which the controller is embedded within the product's web user interface. With a slight difference in the GWN7605LR which is an outdoor Wi-Fi access point that offers extended coverage range support for both indoor and outdoor deployments. Both products are supported by GWN.Cloud and GWN Manager, Grandstream's cloud and on-premise Wi-Fi management platforms. Excellent Wi-Fi APs for voice-over-Wi-Fi deployments and offer a seamless connection with Grandstream's Wi-Fi-capable IP phones. With support for advanced QoS, low-latency real-time applications, mesh networks, captive portals, 100+ concurrent clients per AP and dual Gigabit network ports with PoE/PoE+, they are ideal Wi-Fi access points for medium wireless network deployments with medium user density.

The GWN7660 is a high-efficiency, enterprise-grade 802.11ax Wi-Fi 6 access point, ideal for small-to-medium sized businesses, multiple floor buildings, residential settings and commercial locations. It offers dual-band 2x2:2 MU-MIMO with DL/UL OFDMA technology and a sophisticated antenna design for maximum network throughput and expanded Wi-Fi coverage range. To ensure easy installation and management, the GWN7660 uses a controller-less distributed network management design in which the controller is embedded within the product's Web user interface. The GWN7660 is also supported by GWN.Cloud and GWN Manager, Grandstream's cloud and on-premise Wi-Fi management platform. It is the ideal Wi-Fi AP for voice-over-Wi-Fi deployments and offers a seamless connection with Grandstream's Wi-Fi capable IP phones. With support for advanced QoS, low-latency real-time applications, mesh networks, captive portals, 256 concurrent clients per AP and dual Gigabit network ports with PoE/PoE+, GWN7660 is an ideal Wi-Fi access point for medium wireless network deployments with medium-to-high user density.

---

 **Caution:**

Changes or modifications to this product not expressly approved by Grandstream, or operation of this product in any way other than as detailed by this User Manual, could void your manufacturer warranty.

**Note (VU#228519):** "Out of the box" Grandstream Access Points are not affected by this issue. APs with old firmware are only affected after changing into client-bridge mode. Please refer to our white paper of "WPA Security Vulnerability" [here](#).

---





## PRODUCT OVERVIEW

### Technical Specifications

Table 1: GWN7660 Technical Specifications

<b>Wi-Fi Standards</b>	IEEE 802.11 a/b/g/n/ac/ax.
<b>Antennas</b>	2 dual band internal antennas 2.4GHz, gain 3dBi / 5 GHz, gain 4dBi
<b>Wi-Fi Data Rates</b>	<p><b>5G:</b></p> <p>IEEE 802.11ax: 7.3 Mbps to 1201 Mbps          IEEE 802.11ac: 6.5 Mbps to 867 Mbps          IEEE 802.11n: .5Mbps to 300Mbps          IEEE 802.11a: 6, 9, 12, 18, 24, 36, 48, 54 Mbps</p> <p><b>2.4G:</b></p> <p>IEEE 802.11ax: 7.3 Mbps to 573.5 Mbps          IEEE 802.11n: 6.5Mbps to 300Mbps          IEEE 802.11b: 1, 2, 5.5, 11 Mbps          IEEE 802.11g: 6, 9, 12, 18, 24, 36, 48, 54 Mbps</p> <p><i>*Actual throughput may vary depending on many factors including environmental conditions, distance between devices, radio interference in the operating environment and mix of devices in the network.</i></p>
<b>Frequency Bands</b>	2.4 GHz Radio: 2412 – 2484 GHz 5 GHz Radio: 5180-5825 GHz (FCC, IC, RCM)
<b>Channel Bandwidth</b>	2.4G: 20 and 40 MHz 5G: 20, 40 and 80 MHz
<b>Wi-Fi and System Security</b>	WEP, WPA3, WPA/WPA2-PSK, WPA/WPA2-Enterprise (TKIP/AES), anti-hacking secure boot and critical data/control lockdown via digital signatures, unique security certificate and random default password per device
<b>MIMO</b>	2x2:2 5GHz, 2x2:2 2.4GHz
<b>Coverage Range</b>	575ft. (175 meters) <i>*coverage range can vary based on environment</i>
<b>Maximum TX Power</b>	2.4G: 24 dBm; 5G: 22 dBm <i>*Maximum power varies by country, frequency band and MCS rate</i>
<b>Receiver Sensitivity</b>	<b>2.4G</b> 802.11b: -96dBm@1Mbps, -88dBm@11Mbps; 802.11g: -93dBm @6Mbps, -75dBm@54Mbps;



	<p>802.11n 20MHz: -73dBm @MCS7; 802.11n 40MHz:-70dBm @MCS7; 802.11ax 20MHz: -60dBm @MCS11; 802.11ax 40MHz: -58dBm @MCS11</p> <p><b>5G</b></p> <p>802.11a: -92dBm @6Mbps, -74dBm @54Mbps; 802.11ac 20MHz: -67dBm@MCS8; 802.11ac: HT40:- 63dBm @MCS9; 802.11ac 80MHz: -59dBm @MCS9; 802.11ax 20MHz: -60dBm @MCS11; 802.11ax 40MHz: -58dBm @MCS11;802.11ax 80MHz: -56dBm @MCS11</p> <p><i>Receiver sensitivity varies by frequency band, channel width and MCS rate</i></p>
<b>SSIDs</b>	32 SSIDs total, 16 per radio (2.4GHz and 5GHz)
<b>Concurrent Clients</b>	256
<b>Network Interfaces</b>	2x autosensing 10/100/1000 Base-T Ethernet Ports
<b>Auxiliary Ports</b>	1x Reset Pinhole, 1x Kensington lock
<b>Mounting</b>	Indoor wall mount or ceiling mount, kits included
<b>LEDs</b>	3 tri-color LEDs for device tracking and status indication
<b>Network Protocols</b>	IPv4, 802.1Q, 802.1p, 802.1x, 802.11e/WMM
<b>QoS</b>	802.11e/WMM, VLAN, TOS
<b>Network Management</b>	<p>Embedded controller can manage up to 50 local GWN APs</p> <p>GWN.Cloud offers a free cloud management platform for unlimited GWN APs</p> <p>GWN Manager offers premise-based software controller for up to 3,000 GWN APs</p>
<b>Auto Power Saving</b>	Self-power adaptation upon auto detection of PoE or PoE+
<b>Power and Green Energy Efficiency</b>	<p>Power over Ethernet 802.3af/802.3at compliant</p> <p>Maximum Power Consumption: 9W.</p>
<b>Environmental</b>	<p>Operation: 0°C to 45°C</p> <p>Storage: -10°C to 60°C</p> <p>Humidity: 10% to 90% Non-condensing</p>
<b>Physical</b>	<p>Unit Dimension: 180.4mm x 180.4mm x 40.8mm; Unit Weight: 443g</p> <p>Entire Package Dimension: 228.5x220x79mm; Entire Package Weight: 774g</p>
<b>Package Content</b>	WN7660 802.11ax Wireless AP, Mounting Kits, Quick Start Guide
<b>Compliance</b>	FCC, CE, RCM, IC

**Table 2: GWN7630 Technical Specifications**

<b>Wi-Fi Standards</b>	IEEE 802.11 a/b/g/n/ac (Wave-2).
<b>Antennas</b>	<p>4x 2.4 GHz, gain 4dBi, internal antenna</p> <p>4x 5 GHz, gain 5dBi, internal antenna</p>



<b>Wi-Fi Data Rates</b>	<p>IEEE 802.11ac: 6.5 Mbps to 1733Mbps</p> <p>IEEE 802.11a: 6, 9, 12, 18, 24, 36, 48, 54 Mbps</p> <p>IEEE 802.11n: 6.5Mbps to 600Mbps</p> <p>IEEE 802.11b: 1, 2, 5.5, 11Mbps</p> <p>IEEE 802.11g: 6, 9, 12, 18, 24, 36, 48, 54 Mbps</p> <p><i>*Actual throughput may vary depending on many factors including environmental conditions, distance between devices, radio interference in the operating environment and mix of devices in the network.</i></p>
<b>Frequency Bands</b>	<p>2.4 GHz Radio: 2412 – 2484 GHz</p> <p>5 GHz Radio: 5180-5825 GHz (FCC, IC, RCM)</p>
<b>Channel Bandwidth</b>	<p>2.4G: 20 and 40 MHz</p> <p>5G: 20, 40, 80 MHz</p>
<b>Wi-Fi and System Security</b>	<p>WEP, WPA3, WPA/WPA2-PSK, WPA/WPA2-Enterprise (TKIP/AES), anti-hacking secure boot and critical data/control lockdown via digital signatures, unique security certificate and random default password per device</p>
<b>MIMO</b>	<p>4x4:4 2.4GHz (MIMO)</p> <p>4x4:4 5GHz (MU-MIMO)</p>
<b>Coverage Range</b>	<p>575ft. (175 meters)</p> <p><i>*coverage range can vary based on environment</i></p>
<b>Maximum TX Power</b>	<p>2.4G: 27 dBm; 5G: 25 dBm</p> <p><i>*Maximum power varies by country, frequency band and MCS rate</i></p>
<b>Receiver Sensitivity</b>	<p><b>2.4G</b></p> <p>802.11b: -96dBm@1Mbps, -88dBm@11Mbps; 802.11g: -93dBm @6Mbps, -75dBm@54Mbps; 802.11n 20MHz: -73dBm @MCS7; 802.11n 40MHz:-70dBm @MCS7</p> <p><b>5G</b></p> <p>802.11a: -92dBm @6Mbps, -74dBm @54Mbps; 802.11ac 20MHz: -67dBm@MCS8;</p> <p>802.11ac: HT40:- 63dBm @MCS9; 802.11ac 80MHz: -59dBm @MCS9;</p> <p><i>* Receiver sensitivity varies by frequency band, channel width and MCS rate</i></p>
<b>SSIDs</b>	<p>32 SSIDs total, 16 per radio (2.4GHz and 5GHz)</p>
<b>Concurrent Clients</b>	<p>200+</p>
<b>Network Interfaces</b>	<p>2x autosensing 10/100/1000 Base-T Ethernet Ports</p>
<b>Auxiliary Ports</b>	<p>1x Reset Pinhole, 1x Kensington lock</p>
<b>Mounting</b>	<p>Indoor wall mount or ceiling mount, kits included</p>
<b>LEDs</b>	<p>3 tri-color LEDs for device tracking and status indication</p>



<b>Network Protocols</b>	IPv4, 802.1Q, 802.1p, 802.1x, 802.11e/WMM
<b>QoS</b>	802.11e/WMM, VLAN, TOS
<b>Network Management</b>	Embedded controller in GWN7630 allows it to auto-discover, auto-provision and manage up to 50 GWN76XX in a network GWN.Cloud offers a free cloud management platform for unlimited GWN APs
<b>Auto Power Saving</b>	Self-power adaptation upon auto detection of PoE or PoE+
<b>Power and Green Energy Efficiency</b>	Power over Ethernet 802.3af/802.3at compliant Maximum Power Consumption: 16.5W; Supports 802.3 az.
<b>Environmental</b>	Operation: 0°C to 40°C Storage: -10°C to 60°C Humidity: 10% to 90% Non-condensing
<b>Physical</b>	Unit Dimension: 205.3 x 205.3 x 45.9mm; Unit Weight: 590g Unit + Mounting Kits Dimension: 205.3 x 205.3 x 50.9mm; Unit + Mounting Kits Weight: 710g Entire Package Dimension: 258 x 247 x 86mm; Entire Package Weight:930g
<b>Package Content</b>	GWN7630 802.11ac Wireless AP, Mounting Kits, Quick Start Guide
<b>Compliance</b>	FCC, CE, RCM, IC

**Table 3: GWN7615 Technical Specifications**

<b>Wi-Fi Standards</b>	IEEE 802.11a/b/g/n/ac (Wave-2)
<b>Antennas</b>	3 dual band internal antennas 2.4GHz, gain 3dBi 5 GHz, gain 3dBi
<b>Wi-Fi Data Rates</b>	IEEE 802.11ac: 6.5 Mbps to 1300Mbps IEEE 802.11a: 6, 9, 12, 18, 24, 36, 48, 54 Mbps IEEE 802.11n: 6.5 Mbps to 450 Mbps IEEE 802.11b: 1, 2, 5.5, 11Mbps IEEE 802.11g: 6, 9, 12, 18, 24, 36, 48, 54 Mbps  <i>*Actual throughput may vary depending on many factors including environmental conditions, distance between devices, radio interference in the operating environment and mix of devices in the network</i>
<b>Frequency Bands</b>	2.4 GHz Radio: 2412 – 2484 MHz 5 GHz Radio: 5180-5825 MHz
<b>Channel Bandwidth</b>	2.4G: 20 and 40MHz 5G: 20, 40, and 80MHz

<b>Wi-Fi and System Security</b>	WEP, WPA3, WPA/WPA2-PSK, WPA/WPA2 Enterprise, anti-hacking secure boot and critical data/control lockdown via digital signatures, unique security certificate and random default password per device
<b>MIMO</b>	3×3:3 2.4G(MIMO) 3×3:3 5G(MU-MIMO)
<b>Coverage Range</b>	Up to 175 meters <i>*coverage range can vary based on environment</i>
<b>Maximum TX Power</b>	<b>2.4G:</b> 26 dBm <b>5G:</b> 24 dBm
<b>Receiver Sensitivity</b>	<b>2.4G</b> 802.11b: -96dBm@1Mbps, -88dBm@11Mbps; 802.11g: -93dBm @6Mbps, -75dBm@54Mbps; 802.11n 20MHz: -73dBm @MCS7; 802.11n 40MHz:-70dBm @MCS7 <b>5G</b> 802.11a: -92dBm @6Mbps, -74dBm @54Mbps; 802.11ac 20MHz: -67dBm@MCS8; 802.11ac: HT40:- 63dBm @MCS9; 802.11ac 80MHz: -59dBm @MCS9
<b>SSIDs</b>	32 SSIDs total, 16 per radio (2.4GHz and 5GHz)
<b>Concurrent Clients</b>	200+
<b>Network Interfaces</b>	2× autosensing 10/100/1000 Base-T Ethernet Ports
<b>Auxiliary Ports</b>	1× Reset Pinhole , 1× Kensington lock
<b>Mounting</b>	Indoor wall mount or ceiling mount, kits included
<b>LEDs</b>	1× tri-color LED for device tracking and status indication
<b>Network Protocols</b>	IPv4, IPv6, 802.1Q, 802.1p, 802.1x, 802.11e/WMM
<b>QoS</b>	802.11e/WMM, VLAN, TOS
<b>Network Management</b>	≤ 50 APs: Light-weight Master in AP ≤ 3000 APs: On-Premise controller ≤ +∞ APs: Cloud management
<b>Power and Green Energy Efficiency</b>	POE 802.3af/ 802.3at; Max Consumption: 12.5W
<b>Environmental</b>	Operation: 0°C to 40°C Storage: -10°C to 60°C Humidity: 10% to 90% Non-condensing
<b>Physical</b>	Unit Dimension: 205.4 x 205.4 x 45.9mm; Unit Weight: 500g Entire Package Dimension: 258 x 247 x 86mm; Entire Package Weight: 867.3g
<b>Package Content</b>	GWN7615 802.11ac Wireless AP, Mounting Kits, Quick Start Guide



<b>Compliance</b>	FCC, CE, RCM, IC
-------------------	------------------

**Table 4: GWN7610 Technical Specifications**

<b>Wi-Fi Standards</b>	IEEE 802.11 a/b/g/n/ac
<b>Antennas</b>	3x 2.4 GHz, gain 3 dBi, internal antenna, 3x 5 GHz, gain 3 dBi, internal antenna
<b>Wi-Fi Data Rates</b>	<p>IEEE 802.11ac: 6.5 Mbps to 1300 Mbps</p> <p>IEEE 802.11a: 6, 9, 12, 18, 24, 36, 48, 54 Mbps</p> <p>IEEE 802.11n: 6.5 Mbps to 450 Mbps</p> <p>IEEE 802.11b: 1, 2, 5.5, 11 Mbps</p> <p>IEEE 802.11g: 6, 9, 12, 18, 24, 36, 48, 54 Mbps</p> <p><i>*Actual throughput may vary depending on many factors including environmental conditions, distance between devices, radio interference in the operating environment and mix of devices in the network</i></p>
<b>Frequency Bands</b>	<p>2.4GHz radio: 2.400 - 2.4835 GHz</p> <p>5GHz radio: 5.150 - 5.250 GHz, 5.725 - 5.850 GHz (FCC, IC, RCM)</p>
<b>Channel Bandwidth</b>	<p>2.4G: 20 and 40 MHz</p> <p>5G: 20,40 and 80 MHz</p>
<b>Wi-Fi and System Security</b>	WEP, WPA3, WPA/WPA2-PSK, WPA/WPA2-Enterprise (TKIP/AES), anti-hacking secure boot and critical data/control lockdown via digital signatures, unique security certificate and random default password per device
<b>MIMO</b>	<p>3x3:3 2.4GHz,</p> <p>3x3:3 5GHz</p>
<b>Coverage Range</b>	<p>575ft. (175 meters)</p> <p><i>*coverage range can vary based on environment</i></p>
<b>Maximum TX Power</b>	<p>5G: 26dBm (FCC) / 20dBm (CE)</p> <p>2.4G: 26dBm (FCC) / 17dBm (CE)</p> <p><i>*Maximum power varies by country, frequency band and MCS rate</i></p>
<b>Receiver Sensitivity</b>	<p><b>2.4G</b></p> <p>802.11b:-92dBm@11Mbps; 802.11g:-76dBm@54Mbps; 802.11n 20MHz: -73dBm@MCS7; 802.11n 40MHz:-70dBm@MCS7</p> <p><b>5G</b></p> <p>802.11a:-94dBm@6Mbps; 801.11a:-77dBm@54Mbps; 802.11ac 20MHz: -69dBm@MCS8; 802.11ac HT40:-65dBm@MCS9; 802.11ac 80MHz: 1dBm@MCS9</p>



	* Receiver sensitivity varies by frequency band, channel width and MCS rate
<b>SSIDs</b>	32 SSIDs total, 16 per radio (2.4GHz and 5GHz)
<b>Concurrent Clients</b>	250+
<b>Network Interfaces</b>	2x autosensing 10/100/1000 Base-T Ethernet Ports
<b>Auxiliary Ports</b>	1x USB 2.0 port, 1x Reset Pinhole, 1x Kensington lock
<b>Mounting</b>	Indoor wall mount or ceiling mount, kits included
<b>LEDs</b>	3 multi-color LEDs for device tracking and status indication
<b>Network Protocols</b>	IPv4, 802.1Q, 802.1p, 802.1x, 802.11e/WMM
<b>QoS</b>	802.11e/WMM, VLAN, TOS
<b>Network Management</b>	Embedded controller in GWN7610 allows it to auto-discover, auto-provision and manage up to 50 GWN76XX s in a network. GWN.Cloud offers a free cloud management platform for unlimited GWN Aps
<b>Auto Power Saving</b>	Self-power adaptation upon auto detection of PoE or PoE+
<b>Power and Green Energy Efficiency</b>	DC Input: 24VDC/1A Power over Ethernet 802.3af/802.3at compliant Maximum Power Consumption: 13.8W
<b>Environmental</b>	Operation: 0°C to 50°C Storage: -10°C to 60°C Humidity: 10% to 90% Non-condensing
<b>Physical</b>	Unit Dimension: 205.3 x 205.3 x 45.9mm; Unit Weight: 540g Unit + Mounting Kits Dimension: 205.3 x 205.3 x 50.9mm; Unit + Mounting Kits Weight: 600g Entire Package Dimension: 258 x 247 x 86mm; Entire Package Weight: 900g
<b>Package Content</b>	GWN7610 802.11ac Wireless AP, Mounting Kits, Quick Start Guide
<b>Compliance</b>	FCC, CE, RCM, IC

**Table 5: GWN7605 Technical Specifications**

<b>Wi-Fi Standards</b>	IEEE 802.11 a/b/g/n/ac (Wave-2)
<b>Antennas</b>	2 dual band internal antennas 2.4GHz, gain 3dBi 5 GHz, gain 4dBi

<b>Wi-Fi Data Rates</b>	<p>IEEE 802.11ac: 6.5 Mbps to 867 Mbps</p> <p>IEEE 802.11a: 6, 9, 12, 18, 24, 36, 48, 54 Mbps</p> <p>IEEE 802.11n: 6.5Mbps to 300Mbps.</p> <p>IEEE 802.11b: 1, 2, 5.5, 11 Mbps</p> <p>IEEE 802.11g: 6, 9, 12, 18, 24, 36, 48, 54 Mbps</p> <p><i>* Actual throughput may vary depending on many factors including environmental conditions, distance between devices, radio interference in the operating environment and mix of devices in the network</i></p>
<b>Frequency Bands</b>	<p>2.4GHz radio : 2412 – 2484 MHz</p> <p>5GHz radio : 5180-5825 MHz</p>
<b>Channel Bandwidth</b>	<p>2.4G: 20 and 40 MHz</p> <p>5G: 20,40 and 80 MHz</p>
<b>Wi-Fi and System Security</b>	<p>WEP, WPA3, WPA/WPA2-PSK, WPA/WPA2-Enterprise (TKIP/AES), anti-hacking secure boot and critical data/control lockdown via digital signatures, unique security certificate and random default password per device</p>
<b>MIMO</b>	<p>2x2:2 2.4GHz (MIMO)</p> <p>2x2:2 5GHz (MU-MIMO)</p>
<b>Coverage Range</b>	<p>Up to 165 meters</p> <p><i>*coverage range can vary based on environment</i></p>
<b>Maximum TX Power</b>	<p>5G: 24dBm</p> <p>2.4G: 22dBm</p> <p><i>*Maximum power varies by country, frequency band and MCS rate</i></p>
<b>Receiver Sensitivity</b>	<p><b>2.4G</b></p> <p>802.11b: -96dBm@1Mbps, -88dBm@11Mbps; 802.11g: -93dBm @6Mbps, -75dBm@54Mbps; 802.11n 20MHz: -73dBm @MCS7; 802.11n 40MHz:-70dBm @MCS7</p> <p><b>5G</b></p> <p>802.11a: -92dBm @6Mbps, -74dBm @54Mbps; 802.11ac 20MHz: -67dBm@MCS8; 802.11ac: HT40:- 63dBm @MCS9; 802.11ac 80MHz: -59dBm @MCS9</p> <p><i>* Receiver sensitivity varies by frequency band, channel width and MCS rate</i></p>
<b>SSIDs</b>	<p>16 SSIDs total, 8 per radio (2.4GHz and 5GHz)</p> <p><i>*GWN7605 when deployed as Master can only be added to 8 SSIDs.</i></p>
<b>Concurrent Clients</b>	100+
<b>Network Interfaces</b>	2x autosensing 10/100/1000 Base-T Ethernet Ports
<b>Auxiliary Ports</b>	1x Reset Pinhole, 1x Kensington lock





<b>Mounting</b>	Indoor wall mount or ceiling mount, kits included
<b>LEDs</b>	3 multi-color LEDs for device tracking and status indication
<b>Network Protocols</b>	IPv4, IPv6, 802.1Q, 802.1p, 802.1x, 802.11e/WMM
<b>QoS</b>	802.11e/WMM, VLAN, TOS
<b>Network Management</b>	$\leq$ 50 APs: Light-weight Master in AP $\leq$ 3000 APs: On-Premise controller $\leq$ $+\infty$ APs: Cloud management
<b>Power and Green Energy Efficiency</b>	DC Input: 24VDC/1A Power over Ethernet 802.3af/802.3at compliant Maximum Power Consumption: 13.8W
<b>Environmental</b>	Operation: 0°C to 40°C Storage: -10°C to 60°C Humidity: 10% to 90% Non-condensing
<b>Physical</b>	Unit Dimension: 180.4mmx180.4mmx40.8mm; Unit Weight: 388.2g Entire Package Dimension: 228.5x220x79mm; Entire Package Weight: 719.3g
<b>Package Content</b>	GWN7610 802.11ac Wireless AP, Mounting Kits, Quick Start Guide
<b>Compliance</b>	FCC, CE, RCM, IC

**Table 6: GWN7605LR Technical Specifications**

<b>Wi-Fi Standards</b>	IEEE 802.11a/b/g/n/ac (Wave-2)
<b>Antennas</b>	2 dual band external antennas 2.4GHz, gain 3.5dBi 5 GHz, gain 3.5dBi
<b>Wi-Fi Data Rates</b>	IEEE 802.11ac: 6.5 Mbps to 867 Mbps IEEE 802.11a: 6, 9, 12, 18, 24, 36, 48, 54 Mbps IEEE 802.11n: 6.5Mbps to 300Mbps IEEE 802.11b: 1, 2, 5.5, 11Mbps IEEE 802.11g: 6, 9, 12, 18, 24, 36, 48, 54 Mbps  <i>*Actual throughput may vary depending on many factors including environmental conditions, distance between devices, radio interference in the operating environment and mix of devices in the network</i>
<b>Frequency Bands</b>	2.4GHz Radio: 2412 – 2484 MHz, 5 GHz Radio: 5180-5825 MHz
<b>Channel Bandwidth</b>	2.4G: 20 and 40MHz, 5G: 20, 40 and 80 MHz
<b>Wi-Fi and System Security</b>	WEP, WPA3, WPA/WPA2-PSK, WPA/WPA2 Enterprise, anti-hacking secure boot and critical data/control lockdown via digital signatures, unique security certificate and random default password per device



<b>MIMO</b>	2x2:2 2.4GHz (MIMO) 2x2:2 5GHz (MU-MIMO))
<b>Coverage Range</b>	Up to 250 meters <i>*coverage range can vary based on environment</i>
<b>Maximum TX Power</b>	2.4G: 24 dBm 5G: 22dBm
<b>Receiver Sensitivity</b>	2.4G 802.11b: -96dBm@1Mbps, -88dBm@11Mbps; 802.11g: -93dBm @6Mbps, -75dBm@54Mbps; 802.11n 20MHz: -73dBm @MCS7; 802.11n 40MHz:-70dBm @MCS7 5G 802.11a: -92dBm @6Mbps, -74dBm @54Mbps; 802.11ac 20MHz: -67dBm@MCS8; 802.11ac: HT40:- 63dBm @MCS9; 802.11ac 80MHz: -59dBm @MCS9
<b>SSIDs</b>	16 SSIDs total, 8 per radio (2.4GHz and 5GHz) <i>*GWN7605LR when deployed as Master can only be added to 8 SSIDs.</i>
<b>Concurrent Clients</b>	100+
<b>Network Interfaces</b>	2x autosensing 10/100/1000 Base-T Ethernet Ports
<b>Auxiliary Ports</b>	1x Reset Pinhole
<b>Mounting</b>	Outdoor metal bar mount or wall mount, kits included
<b>LEDs</b>	1 tri-color LED for device tracking and status indication
<b>Network Protocols</b>	IPv4, IPv6, 802.1Q, 802.1p, 802.1x, 802.11e/WMM
<b>QoS</b>	802.11e/WMM, VLAN, TOS
<b>Network Management</b>	Embedded controller can manage up to 50 local GWN APs GWN.Cloud offers a free cloud management platform for almost unlimited GWN Aps GWN.Manager offers premise-based software controller for up to 3,000 GWN APs
<b>Power and Green Energy Efficiency</b>	POE 802.3af/ 802.3at; Maximum Power Consumption: 10.16W
<b>Environmental</b>	Operation: -30°C to 60°C Storage: -30°C to 70°C Humidity: 10% to 90% Non-condensing
<b>Physical</b>	Physical Unit Dimension: 358.3mm(L)*115mm(W)*45.3mm(H); Unit Weight: 500g Entire Package Dimension: 258 x 247x 86mm; Entire Package Weight:655.3g
<b>Package Content</b>	GWN7605LR 802.11ac Wave-2 Wireless AP, Mounting Kits, Quick Start Guide
<b>Water Proof</b>	IP66-level weatherproof capability when installed vertically



<b>Compliance</b>	FCC, CE, RCM, IC
-------------------	------------------

**Table 7: GWN7600 Technical Specifications**

<b>Wi-Fi Standards</b>	IEEE 802.11 a/b/g/n/ac (Wave-2)
<b>Antennas</b>	2x 2.4 GHz, gain 3 dBi, internal antenna, 2x 5 GHz, gain 3 dBi, internal antenna
<b>Wi-Fi Data Rates</b>	<p>IEEE 802.11ac: 6.5 Mbps to 877 Mbps</p> <p>IEEE 802.11a: 6, 9, 12, 18, 24, 36, 48, 54 Mbps</p> <p>IEEE 802.11n: 6.5 Mbps to 300 Mbps; 400 Mbps with 256-QAM on 2.4GHz</p> <p>IEEE 802.11b: 1, 2, 5.5, 11 Mbps</p> <p>IEEE 802.11g: 6, 9, 12, 18, 24, 36, 48, 54 Mbps</p> <p>*Actual throughput may vary depending on many factors including environmental conditions, distance between devices, radio interference in the operating environment and mix of devices in the network.</p>
<b>Frequency Bands</b>	<p>2.4GHz radio : 2.400 - 2.4835 GHz</p> <p>5GHz radio: 5.150 - 5.250 GHz, 5.725 - 5.850 GHz</p>
<b>Channel Bandwidth</b>	<p>2.4G: 20 and 40 MHz</p> <p>5G: 20,40 and 80 MHz</p>
<b>Wi-Fi and System Security</b>	WEP, WPA3, WPA/WPA2-PSK, WPA/WPA2-Enterprise (TKIP/AES), anti-hacking secure boot and critical data/control lockdown via digital signatures, unique security certificate and random default password per device.
<b>MIMO</b>	2x2:2 2.4GHz, 2x2:2 5GHz
<b>Coverage Range</b>	<p>Up to 541ft. (165 meters) for GWN7600.</p> <p>*Coverage range can vary based on environment</p>
<b>Maximum TX Power</b>	<p>5G: 22dBm</p> <p>2.4G: 22dBm</p> <p>*Maximum power varies by country, frequency band and MCS rate.</p>
<b>Receiver Sensitivity</b>	<p><b>2.4G</b></p> <p>802.11b:-99dBm @1Mbps,-91dBm @11Mbps;802.11g:-93dBm @6Mbps,-75dBm @54Mbps; 80.11n 20MHz:-72dBm @MCS7;802.11n 40MHz:-69dBm @MCS7</p> <p><b>5G</b></p> <p>802.11a:-91dBm @6Mbps,-74dBm @54Mbps;802.11ac 20MHz:-67dBm @MCS8;802.11ac HT40:-63dBm @MCS9;802.11ac 80MHz:-60dBm @MCS9</p>



<b>BSSID</b>	32 SSIDs total, 16 per radio (2.4GHz and 5GHz)
<b>Concurrent Clients</b>	450+
<b>Network Interfaces</b>	2x autosensing 10/100/1000 Base-T Ethernet Ports
<b>Auxiliary Ports</b>	1x USB 2.0 port, 1x Reset Pinhole, 1x Kensington lock
<b>Mounting</b>	Indoor wall mount or ceiling mount, kits included
<b>LEDs</b>	multi-color LEDs for device tracking and status indication
<b>Network Protocols</b>	IPv4, 802.1Q, 802.1p, 802.1x, 802.11e/WMM
<b>QoS</b>	802.11e/WMM, VLAN, TOS
<b>Network Management</b>	Embedded controller in GWN7600 allows it to auto-discover, auto-provision and manage up to 30 GWN76XX in a network GWN.Cloud offers a free cloud management platform for unlimited GWN APs
<b>Power and Green Energy Efficiency</b>	DC Input: 24VDC/1A Power over Ethernet (802.3af) compliant Maximum Power Consumption: 13.8W
<b>Temperature &amp; Humidity</b>	Operation: 0°C to 40°C Storage: -10°C to 60°C Humidity: 10% to 90% Non-condensing
<b>Physical</b>	Unit Dimension: 205.3 x 205.3 x 45.9mm; Unit Weight: 526g Unit + Mounting Kits Dimension: 205.3 x 205.3 x 53.9mm; Unit + Mounting Kits Weight : 610g Entire Package Dimension: 228.5*220*79mm; Entire Package Weight: 854g
<b>Package Content</b>	GWN7600 Wave-2 802.11ac Wireless AP, Mounting Kits, Quick Installation Guide
<b>Compliance</b>	FCC, CE, RCM, IC

**Table 8: GWN7600LR Technical Specifications**

<b>Wi-Fi Standards</b>	IEEE 802.11 a/b/g/n/ac (Wave-2)
<b>Antennas</b>	2x 2.4 GHz, gain 4 dBi, internal antenna 2x 5 GHz, gain 5 dBi, internal antenna
<b>Wi-Fi Data Rates</b>	IEEE 802.11ac: 6.5 Mbps to 867 Mbps IEEE 802.11a: 6, 9, 12, 18, 24, 36, 48, 54 Mbps IEEE 802.11n: 6.5 Mbps to 300 Mbps; 400Mbps with 256-QAM on 2.4GHz IEEE 802.11b: 1, 2, 5.5, 11 Mbps IEEE 802.11g: 6, 9, 12, 18, 24, 36, 48, 54 Mbps  *Actual throughput may vary depending on many factors including environmental conditions, distance between devices, radio interference in the operating environment and mix of devices in the network



<b>Frequency Bands</b>	2.4GHz radio: 2.400 - 2.4835 GHz 5GHz radio: 5.150 - 5.250 GHz, 5.725 - 5.850 GHz
<b>Channel Bandwidth</b>	2.4G: 20 and 40 MHz 5G: 20,40 and 80 MHz
<b>Wi-Fi and System Security</b>	WEP, WPA3, WPA/WPA2-PSK, WPA/WPA2 Enterprise (TKIP/AES), anti-hacking secure boot and critical data/control lockdown via digital signatures, unique security certificate and random default password per device
<b>MIMO</b>	2x2:2 2.4GHz (MIMO), 2x2:2 5GHz (MU-MIMO)
<b>Coverage Range</b>	Up to 984ft. (300 meters) *Coverage range can vary based on environment
<b>Maximum TX Power</b>	5G: 22dBm (FCC) / 20dBm (CE) 2.4G: 22dBm (FCC) / 17dBm (CE) *Maximum power varies by country, frequency band and MCS rate
<b>Receiver Sensitivity</b>	<b>2.4G</b> 802.11b: -99dBm@1Mbps, -91dBm@11Mbps; 802.11g:-93dBm@6Mbps, -75dBm@54Mbps; 802.11n 20MHz: -72dBm@MCS7; 802.11n 40MHz: -69dBm @MCS7 <b>5G</b> 802.11a: -91dBm@6Mbps, -74dBm@54Mbps; 802.11ac 20MHz: -67dBm@MCS8; 802.11ac; HT40: -63dBm@MCS9; 802.11ac 80MHz: -60dBm@MCS9
<b>SSIDs</b>	32 SSIDs total, 16 per radio (2.4GHz and 5GHz)
<b>Concurrent Clients</b>	450+
<b>Network Interfaces</b>	2x autosensing 10/100/1000 Base-T Ethernet Ports
<b>Auxiliary Ports</b>	1x Reset Pinhole
<b>Mounting</b>	Outdoor base bracket and cover bracket included
<b>LEDs</b>	multicolor LED for device tracking and status indication
<b>Network Protocols</b>	IPv4, 802.1Q, 802.1p, 802.1x, 802.11e/WMM
<b>QoS</b>	802.11e/WMM, VLAN, TOS
<b>Network Management</b>	Embedded controller in GWN7600LR allows it to auto-discover, auto-provision and manage up to 30 GWN76XX s in a network GWN.Cloud offers a free cloud management platform for unlimited GWN APs
<b>Power and Green Energy Efficiency</b>	Power over Ethernet 802.3af and 802.3at compliant Maximum Power Consumption: 12.9 W (PoE supply)   23.0 W (PoE+ supply)
<b>Temperature &amp; Humidity</b>	Operation: -30°C to 60°C Storage: -30°C to 70°C Humidity: 5% to 95% Non-condensing



<b>Physical</b>	Unit Dimension: 290x150x35mm; Unit Weight: 708g Unit + Mounting Kits Dimension: 290x150x56mm; Unit + Mounting Kits Weight: 1528.2g Entire Package Dimension: 423x187x97mm; Entire Package Weight: 1844g
<b>Package Content</b>	Enterprise 802.11ac Wave-2 Outdoor Long Range Wi-Fi Access Point, Mounting Kits, Quick Installation Guide
<b>Waterproof Grade</b>	IP66-level weatherproof capability when installed vertically
<b>Compliance</b>	FCC, CE, RCM, IC

**Table 9: GWN7630LR Technical Specifications**

<b>Wi-Fi Standards</b>	IEEE 802.11 a/b/g/n/ac (Wave-2)
<b>Antennas</b>	4 detachable/changeable dual-band omnidirectional antennas 2.4GHz, gain 3.5dBi; 5GHz, gain 3.5dB
<b>Wi-Fi Data Rates</b>	IEEE 802.11ac: 6.5 Mbps to 1733Mbps IEEE 802.11a: 6, 9, 12, 18, 24, 36, 48, 54 Mbps IEEE 802.11n: 6.5Mbps to 600Mbps IEEE 802.11b: 1, 2, 5.5, 11Mbps IEEE 802.11g: 6, 9, 12, 18, 24, 36, 48, 54 Mbps  *Actual throughput may vary depending on many factors including environmental conditions, distance between devices, radio interference in the operating environment and mix of devices in the network
<b>Frequency Bands</b>	2.4 GHz Radio: 2412 – 2484 MHz 5GHz Radio: 5150-5250MHz, 5250-5350MHz, 5470-5725MHz, 5725-5850MHz  *Not all frequency bands can be used in all regions.
<b>Channel Bandwidth</b>	2.4G: 20 and 40 MHz; 5G: 20,40 and 80 MHz
<b>Wi-Fi and System Security</b>	WEP, WPA3, WPA/WPA2-PSK, WPA/WPA2 Enterprise, anti-hacking secure boot and critical data/control lockdown via digital signatures, unique security certificate and random default password per device
<b>MIMO</b>	4x4:4 2.4G (MIMO), 4x4:4 5G (MU-MIMO)
<b>Coverage Range</b>	Up to 984ft. (300 meters)  *Coverage range can vary based on environment
<b>Maximum TX Power</b>	2.4G: 27 dBm 5G: 25 dBm  *Maximum power varies by country, frequency band and MCS rate
<b>Receiver</b>	<b>2.4G</b>



<b>Sensitivity</b>	802.11b: -96dBm@1Mbps, -88dBm@11Mbps; 802.11g: -93dBm @6Mbps, -75dBm@54Mbps; 802.11n 20MHz: -73dBm @MCS7; 802.11n 40MHz:-70dBm @MCS7  <b>5G</b> 802.11a: -92dBm @6Mbps, -74dBm @54Mbps; 802.11ac 20MHz: -67dBm@MCS8; 802.11ac: HT40:- 63dBm @MCS9; 802.11ac 80MHz: -59dBm @MCS9
<b>SSIDs</b>	32 SSIDs total, 16 per radio (2.4GHz and 5GHz)
<b>Concurrent Clients</b>	200+
<b>Network Interfaces</b>	2x autosensing 10/100/1000 Base-T Ethernet Ports
<b>Auxiliary Ports</b>	1x Reset Pinhole
<b>Mounting</b>	Wall mount or pole mount - kits included
<b>LEDs</b>	1x tri-color LEDs for device tracking and status indication
<b>Network Protocols</b>	IPv4, 802.1Q, 802.1p, 802.1x, 802.11e/WMM
<b>QoS</b>	802.11e/WMM, VLAN, TOS
<b>Network Management</b>	Embedded controller can manage up to 50 local GWN APs GWN.Cloud offers a free cloud management platform for unlimited GWN APs
<b>Power and Green Energy Efficiency</b>	PoE 802.3af/ 802.3at; Max Consumption: 16.5W
<b>Temperature &amp; Humidity</b>	Operation: -30°C to 60°C Storage: -30°C to 70°C Humidity: 5% to 95% Non-condensing
<b>Physical</b>	Unit Dimension: 533.1 × 115 × 40mm; Unit Weight: 564g Unit + Mounting Kits Dimension : 533.1×115 x62mm; Unit + Mounting Kits Weight : 706g Entire Package Dimension: 258 × 247× 86mm; Entire Package Weight: 978g
<b>Package Content</b>	GWN7630LR 802.11ac Wireless AP, Mounting Kits, Quick Installation Guide
<b>Waterproof Grade</b>	IP66-level weatherproof capability when installed vertically
<b>Compliance</b>	FCC, CE, RCM, IC



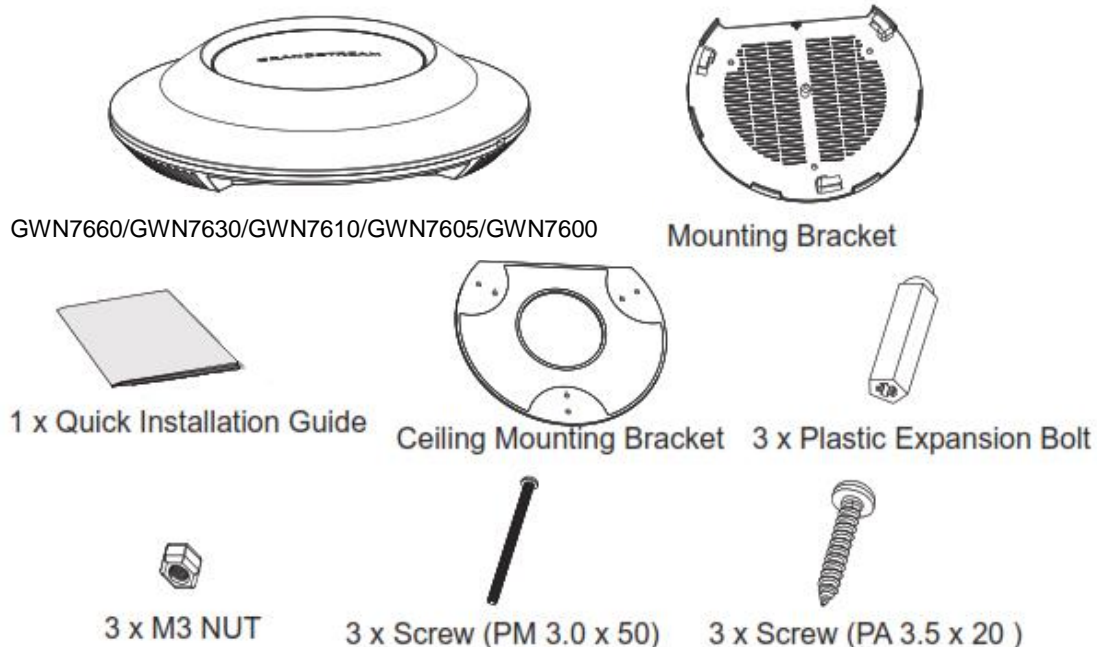
## INSTALLATION

Before deploying and configuring the GWN76XX, the device needs to be properly powered up and connected to the network. This section describes detailed information on installation, connection and warranty policy of the GWN76XX.

### Equipment Packaging

**Table 10: GWN7660/GWN7630/GWN7610/GWN7615/GWN7605/GWN7600 Equipment Packaging**

<b>Main Case (GWN7660, GWN7630 or GWN7610 or GWN7615 or GWN7605 or GWN7600)</b>	Yes (1)
<b>Mounting Bracket</b>	Yes (1)
<b>Ceiling Mounting Bracket</b>	Yes (1)
<b>Plastic Expansion Bolt</b>	Yes (3)
<b>M3 NUT</b>	Yes (3)
<b>Screw (PM 3 x 50)</b>	Yes (3)
<b>Screw (PM 3.5 x 20)</b>	Yes (3)
<b>Quick Installation Guide</b>	Yes (1)



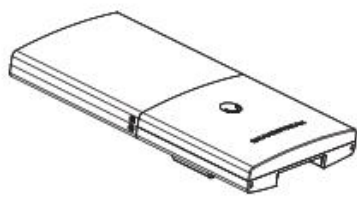
**Figure 1: GWN7660/GWN7630/GWN7610/GWN7605/GWN7600 Equipment Packaging**

Below is the equipment packaging for GWN7600LR model.



**Table 11: GWN7600LR Equipment Packaging**

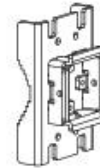
<b>Main Case</b>	Yes (1)
<b>Cover Interface</b>	Yes (1)
<b>Base Bracket</b>	Yes (1)
<b>Cover Bracket</b>	Yes (1)
<b>Assembled Screw</b>	Yes (4)
<b>Locknut</b>	Yes (4)
<b>Anchors + Screws</b>	Yes (4)
<b>Screw (PM8 x 115)</b>	Yes (4)
<b>Quick Installation Guide</b>	Yes (1)



1 x GWN7600LR Access Point



1 x Cover Bracket



1 x Base Bracket



4 x Screw (PM8 x 115)



2 x Assembled Screw



4 x Screws and Anchors



4 x Locknut



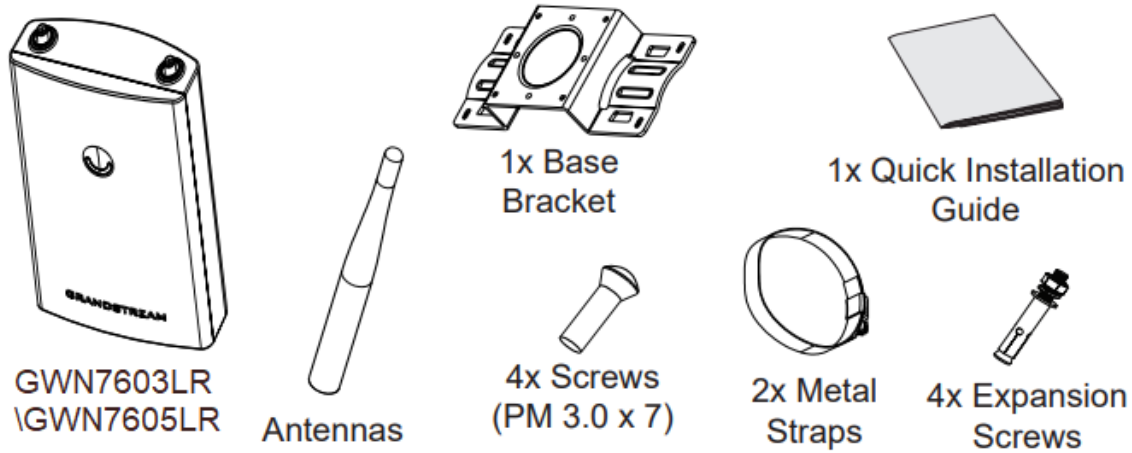
1 x Quick Installation Guide

**Figure 2: GWN7600LR Equipment Package**

Below is the equipment packaging for GWN7630LR/ GWN7605LR model.

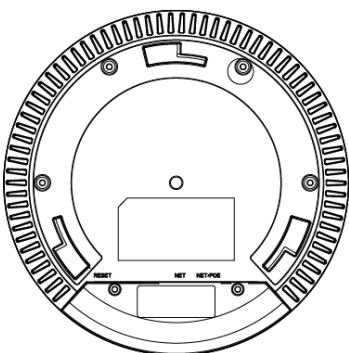
**Table 12: GWN7630LR Equipment Packaging**

<b>Main Case</b>	Yes (1)
<b>Antenna</b>	GWN7630LR: Yes (4) GWN7605LR: Yes (2)
<b>Base Bracket</b>	Yes (1)
<b>Screw (PM 3.0x7)</b>	Yes (4)
<b>Expansion Screw</b>	Yes (4)
<b>Metal Strap</b>	Yes (2)
<b>Quick Installation Guide</b>	Yes (1)

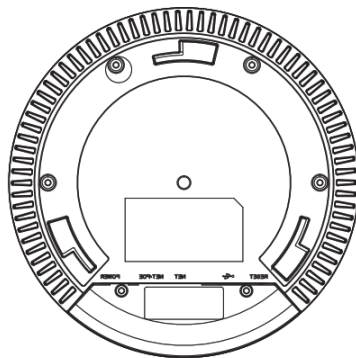


**Figure 3: GWN7630LR/GWN7605LR Equipment Package**

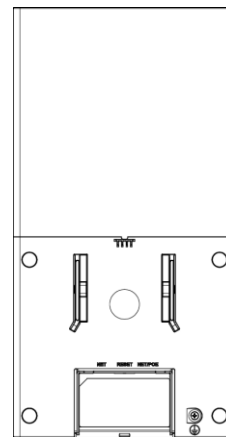
## GWN76XX Access Point Ports



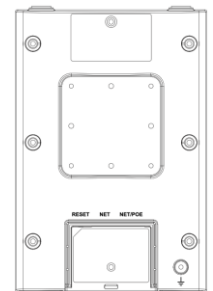
**Figure 4: GWN7660/GWN7630/GWN7615  
/GWN7605 Ports**



**Figure 5: GWN7610/GWN7600 Ports**




**Figure 6: GWN7600LR Ports**



**Figure 7: GWN7630LR  
/GWN7605LR Ports**

**Table 13: GWN76XX AP Ports Description**

Port	Description
<b>Power</b>	Power adapter connector (24V, 1A) * Available on GWN7610 and GWN7600 only
<b>NET/PoE</b>	Ethernet RJ45 port (10/100/1000Mbps) supporting PoE/PoE+. * GWN7600 supports PoE (802.3af) only
<b>NET</b>	Ethernet RJ45 port (10/100/1000Mbps) to your router or another GWN76XX series.
	USB 2.0 port (for future IOT & location-based applications) * Available on GWN7610 and GWN7600 only
<b>RESET</b>	Factory reset button. Press for 7 seconds to reset factory default settings. Quick press will only reboot the unit.

## Power and Connect GWN76XX Access Point

### Step 1:

Connect one end of a RJ-45 Ethernet cable into the NET or PoE/NET port of the GWN76XX unit.

### Step 2:

Connect the other end of the Ethernet cable(s) into a LAN port to your Network. (Use PoE/PoE+ switch for GWN7615/GWN7605/ GWN7605LR/GWN7600LR).

### Step 3:

For GWN7610/GWN7600 only, connect the 24V DC power adapter into the power jack on the back of the access point. Insert the main plug of the power adapter into a surge-protected power outlet. Otherwise, PoE can be used if the switch port does provide PoE power.

### Notes:

- GWN7660/GWN7630/GWN7615/GWN7610/GWN7605/GWN7605LR/GWN7600LR/GWN7630LR can be powered using PoE(802.3af)/PoE+(802.3at) switch via PoE/NET port while GWN7600 can be powered using PoE (802.3af) switch via PoE/NET port. In this case, both power and network connectivity will be provided over the PoE/NET port.
- GWN7630/GWN7610 has a PoE detection daemon that will monitor the status and update maximum allowable power for USB ports in real time.

#### Step 4:

Wait for the GWN76XX to boot up and acquire an IP address from the DHCP Server.

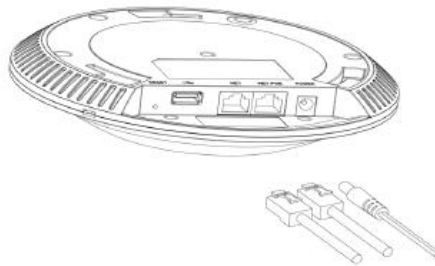


Figure 8: Connecting GWN AP - GWN7600 as example

## Warranty

If the GWN76XX Wireless Access Point was purchased from a reseller, please contact the company where the device was purchased for replacement, repair or refund.

If the device was purchased directly from Grandstream, contact our Technical Support Team for an RMA (Return Materials Authorization) number before the product is returned. Grandstream reserves the right to remedy warranty policy without prior notification.

## Wall/Ceiling Mount Installation GWN76XX

GWN7660/GWN7630/GWN7610/GWN7615/GWN7600/GWN7605 can be mounted on the wall or ceiling, please refer to the following steps for the appropriate installation. This is the GWN7600 example:

### Wall Mount

#### Step 1:

Position the mounting bracket at the desired location on the wall with the arrow pointing up.

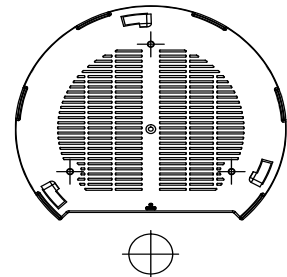


Figure 9: Wall Mount – Steps 1 & 2

#### Step 2:

Use a pencil to mark the four mounting holes (screw holes DIA 5.5mm, reticle hole DIA 25mm).

#### Step 3:

Insert screw anchors into the 5.5 mm holes. Attach the mounting bracket to the wall by inserting the screws into the anchors.

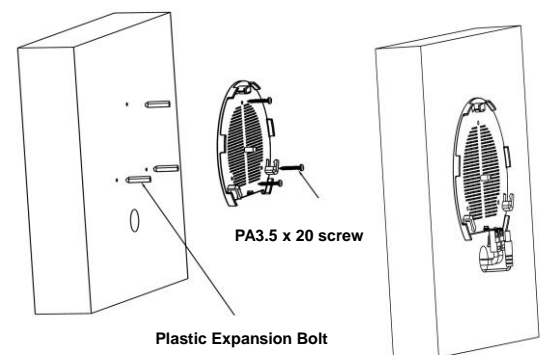


Figure 10: Wall Mount – Steps 3 & 4



**Step 4:**

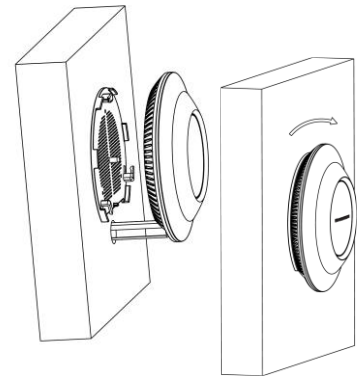
Connect the power cable and the Ethernet cable (RJ45) to the correct ports of your GWN7660/GWN7630/GWN7610/GWN7615/GWN7605 /GWN7600.

**Step 5:**

Align the arrow on the GWN AP with the arrow on the locking tab of the mounting bracket and ensure that your GWN is firmly seated on the mounting bracket.

**Step 6:**

Turn the GWN clockwise until it locks into place and fits the locking tab.



**Figure 11: Wall Mount – Steps 5 & 6**

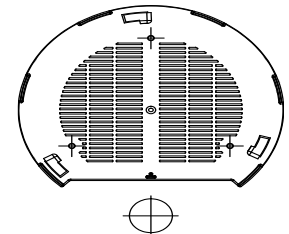
**Ceiling Mount**

**Step 1:**

Remove the ceiling tile.

**Step 2:**

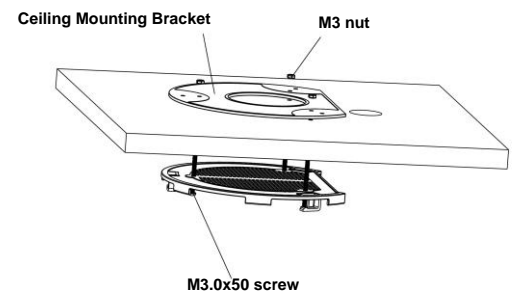
Place the ceiling backing plate in the center of the ceiling tile and mark the mounting screw holes (screw holes DIA 5.5mm, reticle hole DIA 25mm).



**Figure 12: Ceiling Mount – Steps 1 & 2**

**Step 3:**

Insert the screws through the mounting bracket.



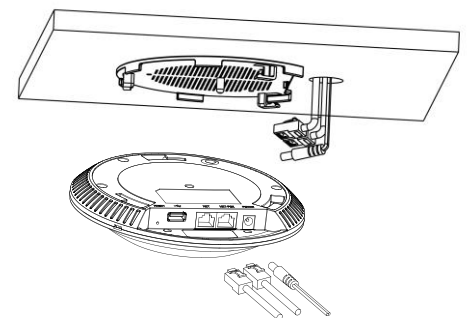
**Figure 13: Ceiling Mount – Step 3**

**Step 4:**

Connect the power cable and the Ethernet cable (RJ45) to the correct ports of your GWN76XX.

**Step 5:**

Align the arrow on the GWN AP with the arrow on the locking tab of the mounting bracket and ensure that your GWN is firmly seated on the mounting bracket and connect the network and power cables.



**Figure 14: Ceiling Mount – Step 4**

**Step 6:**

Turn the GWN clockwise until it locks into place and fits the locking tab.



Ceiling mounting is recommended for optimal coverage performance.

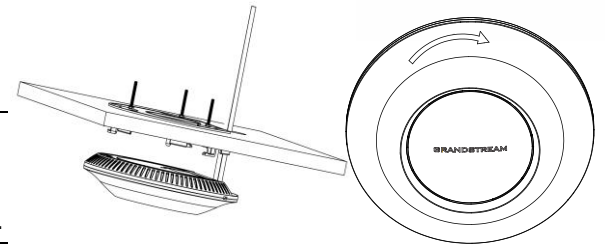


Figure 15: Ceiling Mount – Steps 5 & 6

## Mounting Instructions for GWN7600LR

Please refer to the following steps for the mounting your GWN7600LR correctly.

1. Prepare the Cover Bracket by inserting the 4 screws (PM8) into corresponding holes.
2. Attach the Cover Bracket with screws on the vertical/horizontal Mounting Bolt were GWN7600LR will be installed.
3. Assemble the Base Bracket with the Cover Bracket using provided locknuts and screws (PM8).
4. Connect the Ethernet cable (RJ45) to the correct ports of your GWN7600LR.
5. Align the GWN7600LR with the Base Bracket and pull it down to the right position.
6. Install the 2x Assembled screws to fix GWN7600LR on the Mounting Bolt.

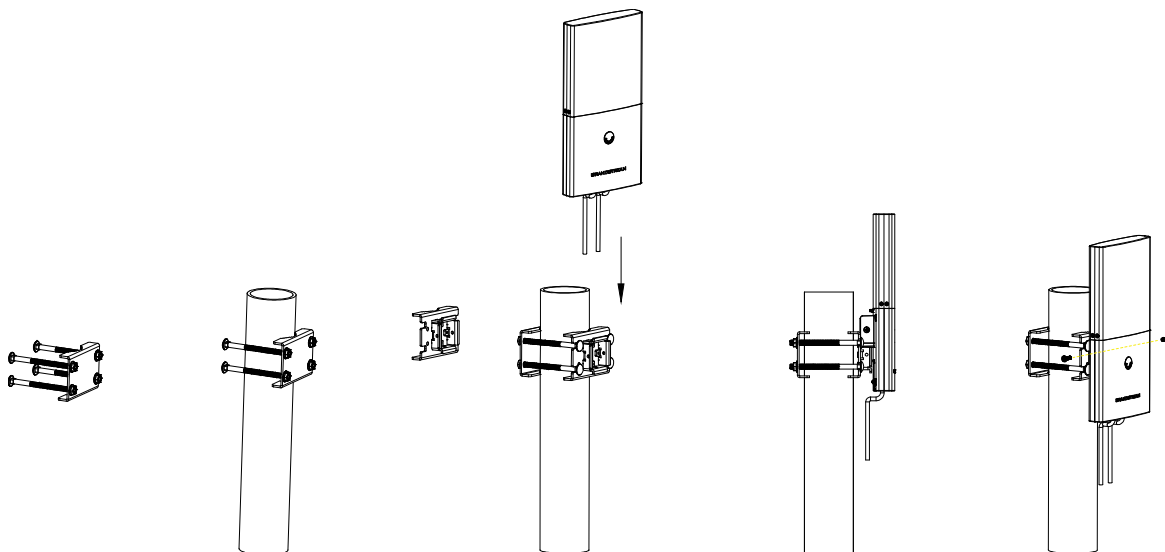


Figure 16: GWN7600LR Vertical Mounting

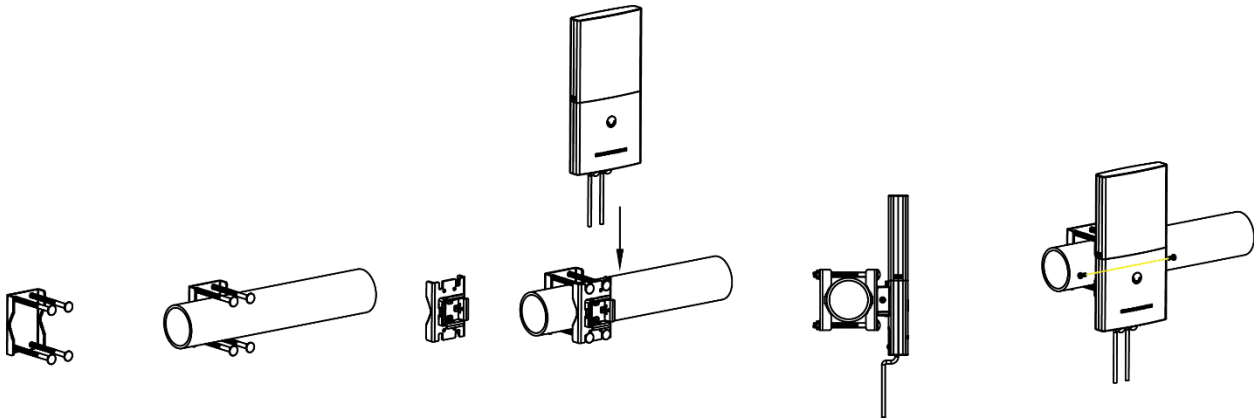


Figure 17: GWN7600LR Horizontal Mounting

## Mounting Instructions for GWN7630LR/GWN7605LR

GWN7630LR can be mounted on the wall or on a metal bar. Please refer to the following steps for the appropriate installation.

1. Connect the Ethernet cable (RJ45) to the correct port of your GWN7630LR/GWN7605LR and insert the cover bracket.
2. Connect each antenna to an antenna connector by rotating it clockwise.
3. Attach the Base bracket with screws (PM 3.0x7) on the back of GWN7630LR /GWN7605LR access point.

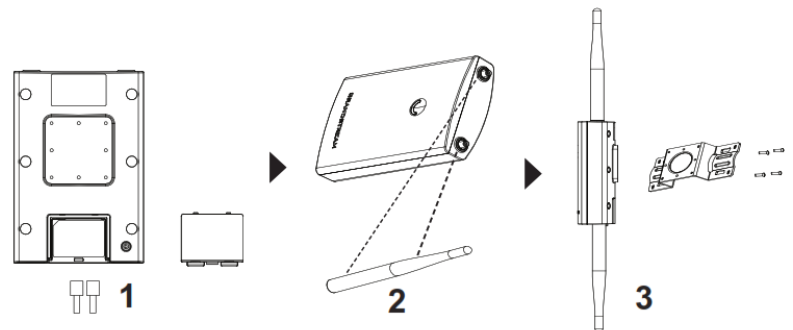


Figure 18: GWN7630LR/GWN7605LR Mounting Instructions

### Wall Mount

4. Drill four holes on the wall referring to the positions of the ones on the base bracket. Then, fix an expansion screw in each hole.
5. Attach the GWN7630LR/GWN7605LR access point by securing the Base Bracket with the expansion screws on the wall.

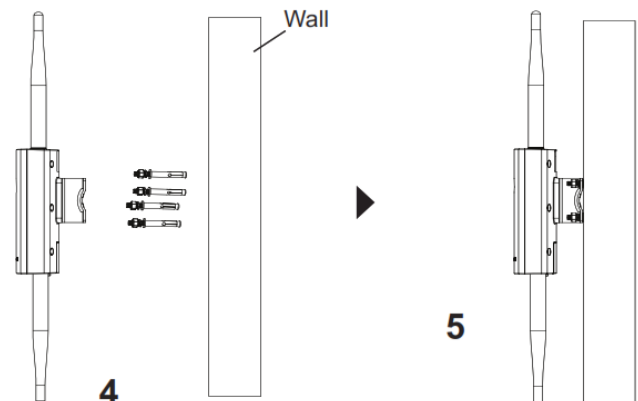


Figure 19: GWN7630LR/GWN7605LR Wall Mount

## Pole Mount

4. Open the metal straps by turning the locking mechanism counter-clockwise. You can loosen it by hand or use a flathead screwdriver.
5. Straighten out the end of the metal straps and slide it through the back of the base bracket.
6. Wrap the metal strap around the pole and use a flathead screwdriver to tighten the locking mechanism by turning it clockwise.

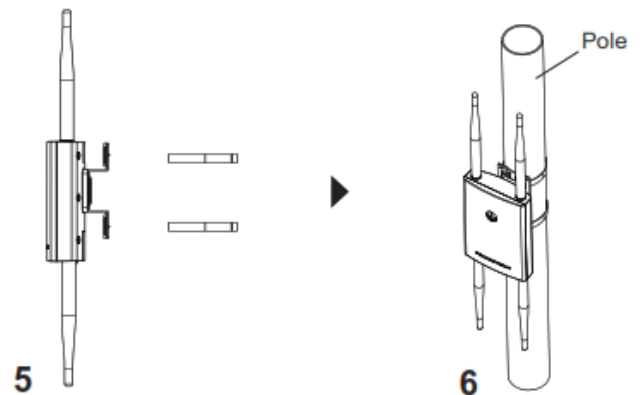


Figure 20: GWN7630LR/GWN7605LR Pole Mount



## GETTING STARTED

The GWN76XX Wireless Access Point provides an intuitive web GUI configuration interface for easy management to give users access to all the configurations and options for the GWN76XX's setup.

This section provides step-by-step instructions on how to read LED patterns, discover the GWN76XX and use its Web GUI interface.

### LED Patterns

The panel of the GWN76XX has different LED patterns for different activities, to help users read the status of the GWN76XX whether it's powered up correctly, provisioned, in upgrading process and more, for more details please refer to the below table.

**Table 14: LED Patterns**

LED Status	Indication
<b>OFF</b>	Unit is powered off or abnormal power supply.
<b>Blinking green</b>	Firmware update in progress.
<b>Solid green</b>	Firmware update successful.
<b>Blinking red</b>	Delete paired slave - Factory reset initiated.
<b>Solid red</b>	Firmware update failed.
<b>Solid purple</b>	Unit not provisioned.
<b>Blinking blue</b>	Unit provisioning in progress.
<b>Solid blue</b>	Unit is provisioned successfully.
<b>Blinking White</b>	Used for Access Point location feature
<b>Yellow</b>	Mesh disconnection.



## Discover the GWN76XX

Once the GWN76XX is powered up and connected to the Network correctly, users can discover the GWN76XX using one of the below methods:

### Method1: Discover the GWN76XX using its MAC address

1. Locate the MAC address on the MAC tag of the unit, which is on the underside of the device, or on the package.
2. From a computer connected to same Network as the GWN76XX , type in the following address using the GWN76XX's MAC address on your browser [https://gwn\\_<mac>.local](https://gwn_<mac>.local)  
For example, if a GWN76XX has the MAC address **00:0B:82:8B:58:30**, this unit can be accessed by typing [https://gwn\\_000b828b5830.local/](https://gwn_000b828b5830.local/) on the browser.

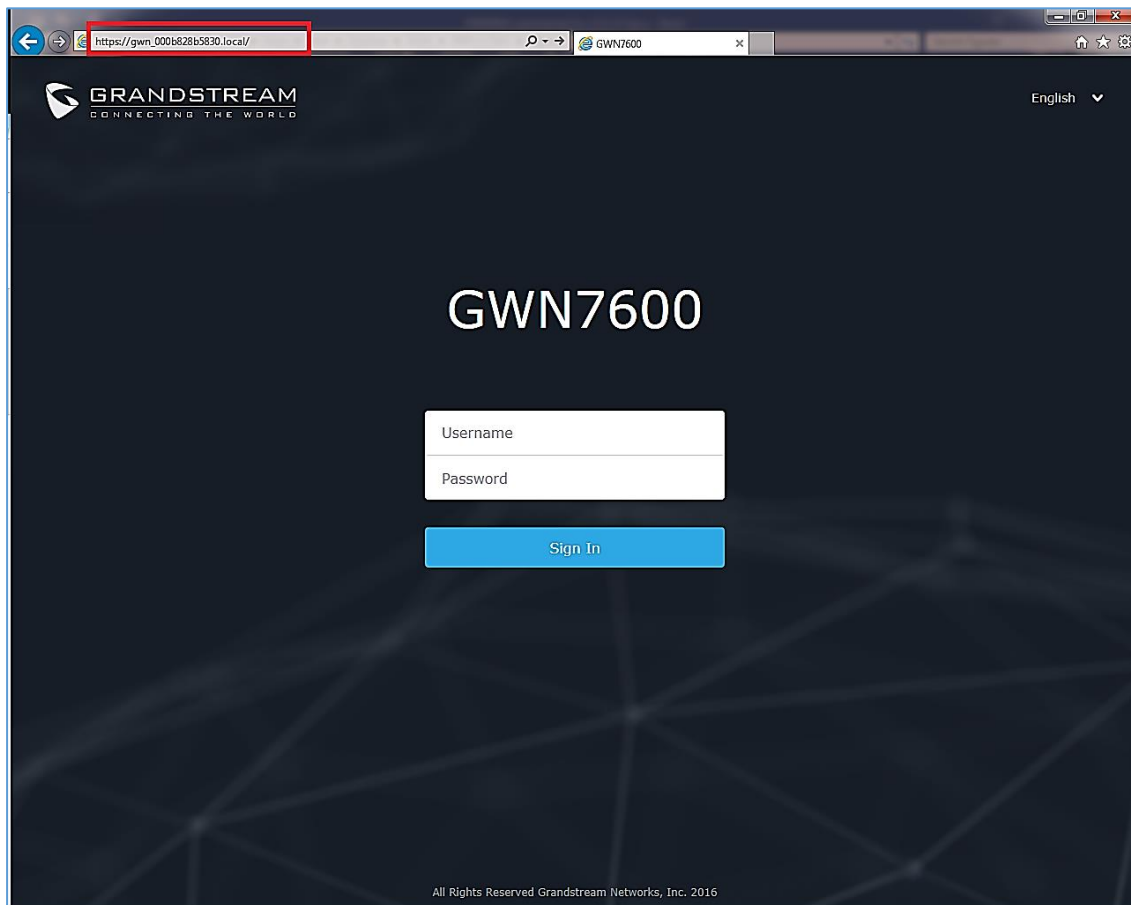
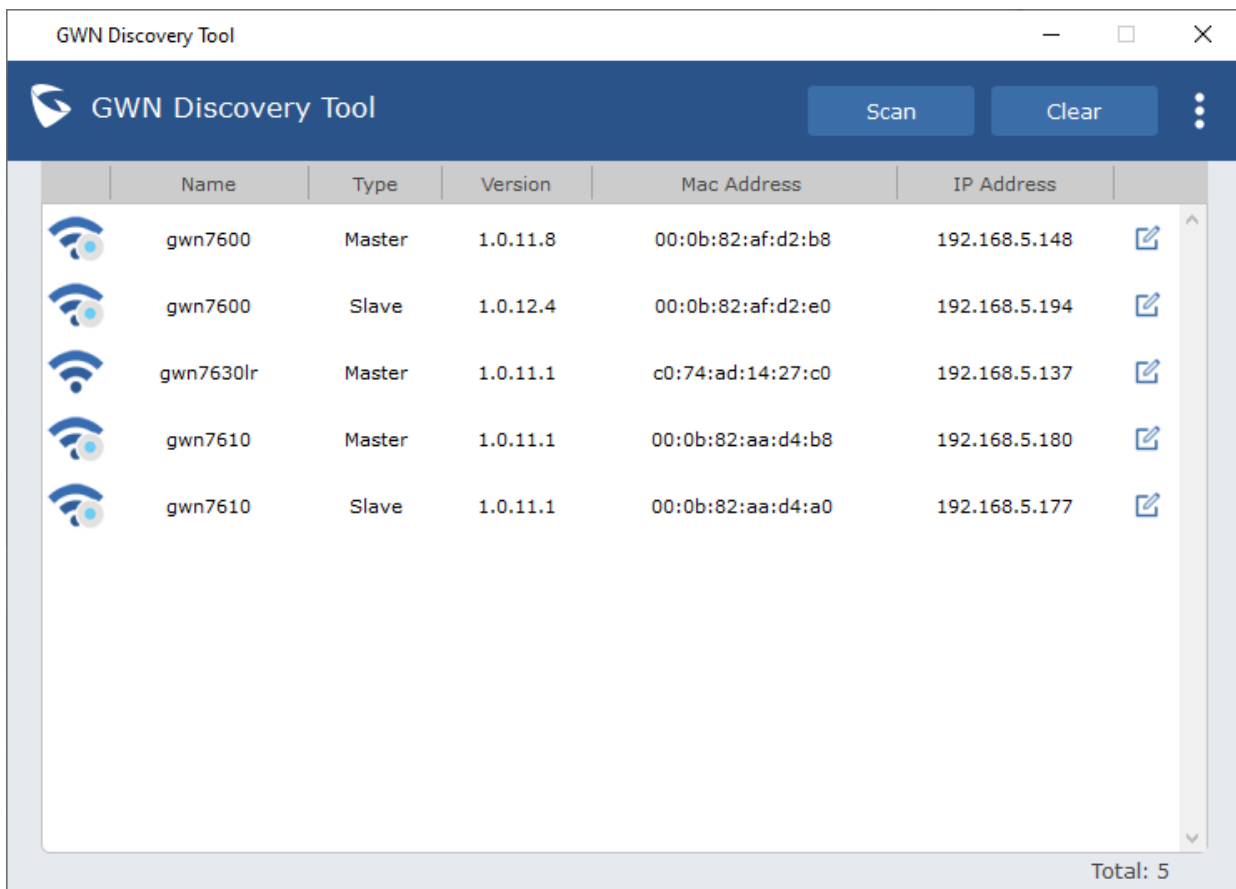


Figure 21: Discover the GWN76XX using its MAC Address

## Method 2: Discover the GWN76XX using GWN Discovery Tool

1. Download and install **GWN Discovery Tool** from the following link:  
<http://www.grandstream.com/support/tools>
2. Open the GWNDiscoveryTool, click on **Select** to define the network interface, then click on **Scan**.
3. The tool will discover all GWN76XX Access Points connected on the network showing their MAC, IP addresses and firmware version.
4. Click on **Manage Device** to be redirected directly to the GWN76XX's configuration interface, or type in manually the displayed IP address on your browser.



The screenshot shows the GWN Discovery Tool interface. At the top, there is a header with the Grandstream logo and the text "GWN Discovery Tool". Below the header, there are two buttons: "Scan" and "Clear". A table displays the results of the scan, with columns for Name, Type, Version, Mac Address, and IP Address. Each row also includes a Wi-Fi icon and a link icon. At the bottom right of the table area, it says "Total: 5".

Name	Type	Version	Mac Address	IP Address
gwn7600	Master	1.0.11.8	00:0b:82:af:d2:b8	192.168.5.148
gwn7600	Slave	1.0.12.4	00:0b:82:af:d2:e0	192.168.5.194
gwn7630lr	Master	1.0.11.1	c0:74:ad:14:27:c0	192.168.5.137
gwn7610	Master	1.0.11.1	00:0b:82:aa:d4:b8	192.168.5.180
gwn7610	Slave	1.0.11.1	00:0b:82:aa:d4:a0	192.168.5.177

Total: 5

Figure 22: GWN Discovery Tool

## Use the Web GUI

Users can access then the GWN76XX using its WebGUI, the following sections will explain how to access and use the Web Interface.

## Access Web GUI

The GWN76XX embedded Web server responds to HTTPS GET/POST requests. Embedded HTML pages allow users to configure the device through a Web browser such as Microsoft IE, Mozilla Firefox, Google Chrome and etc.

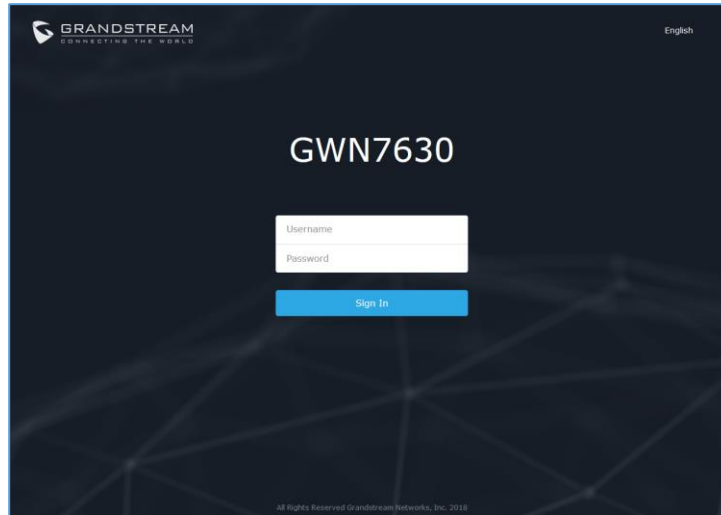


Figure 23: GWN76XX Web GUI Login Page

To access the Web GUI:

1. Make sure to use a computer connected to the same local Network as the GWN76XX.
2. Ensure the device is properly powered up.
3. Open a Web browser on the computer and type in the URL using the MAC address as shown in [Discover the GWN76XX ] or the IP address using the following format: [https://IP\\_Address](https://IP_Address)
4. Enter the administrator's login and password to access the Web Configuration Menu. The default administrator's username is always "admin" and password is the unique default *Wi-Fi Password* available on the sticker on the back of the unit.

## WEB GUI Languages

Currently the GWN76XX series web GUI supports **English** and **Simplified Chinese**.

Users can select the displayed language at the upper right of the web GUI either before or after login.

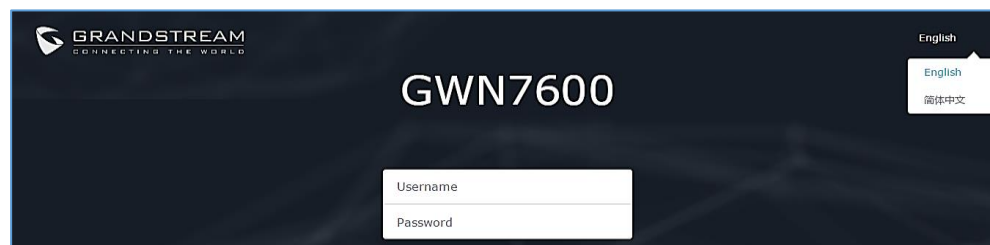


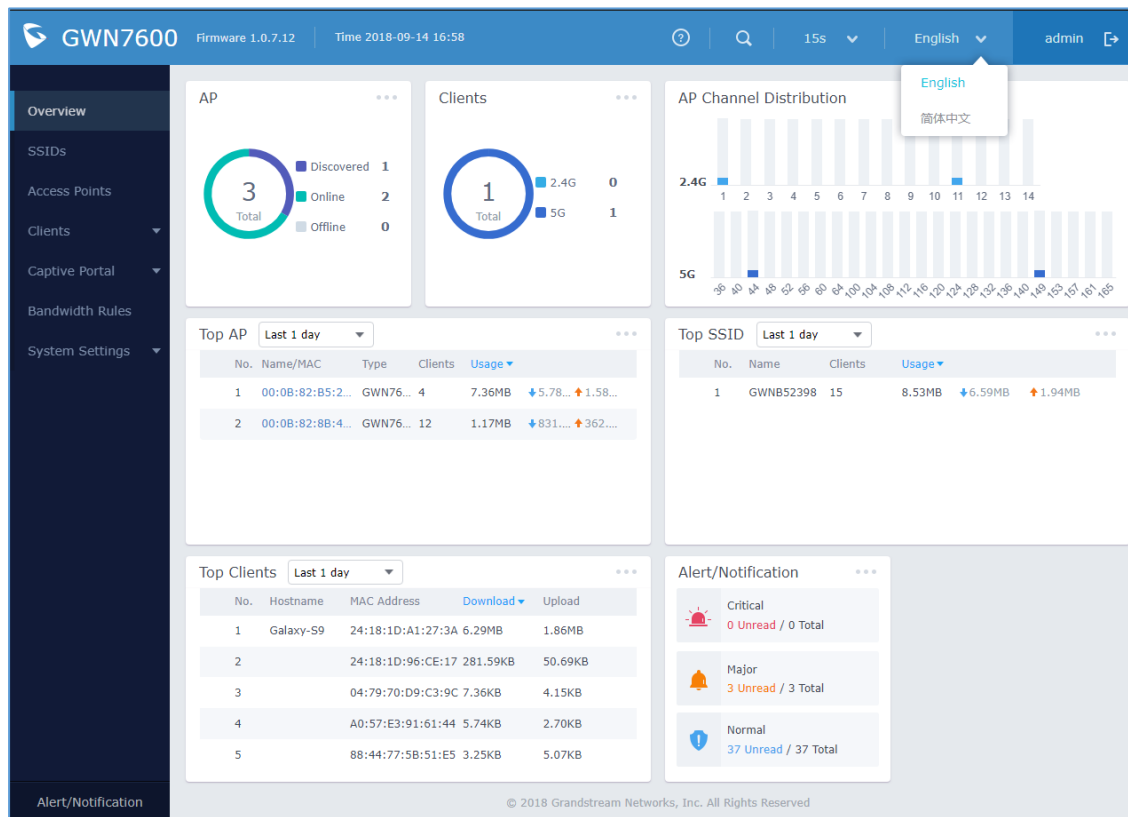
Figure 24: GWN76XX Web GUI Language (Login page)



**Figure 25: GWN76XX Web GUI Language (Web Interface)**

## Overview Page


Overview is the first page shown after successful login to the GWN76XX's Web Interface. Overview page provides an overall view of the GWN76XX information presented in a Dashboard style for easy monitoring along with firmware version and date-time information at the top.








**Figure 26: GWN76XX Dashboard (GWN7600 as example)**


Users can quickly see the status of the GWN76XX for different items, please refer to the following table:

**Table 15: Overview**

<b>AP</b>	Shows the number of Access Point that are Discovered, Paired (Online) and Offline. Users may click on  to go to Access Points page for basic and advanced configuration options for the APs.
-----------	---




<b>Clients</b>	Shows the total number of connected clients, and a count for clients connected to each Channel. Users may click on  to go to Clients page for more options.
<b>AP Channel Distribution</b>	Shows the Channel used for all APs that are paired with this Access Point.
<b>Top AP</b>	Shows the Top APs list, users may assort the list by number of clients connected to each AP or data usage combining upload and download. Users may click on  to go to Access Points page for basic and advanced configuration options for the APs.
<b>Top SSID</b>	Shows the Top SSIDs list, users may assort the list by number of clients connected to each SSID or data usage combining upload and download. Users may click on  to go to SSID page for more options.
<b>Top Clients</b>	Shows the Top Clients list, users may assort the list of clients by their upload or download. Users may click on  to go to Clients page for more options.
<b>Alert/Notification</b>	Shows 3 types of Alert/Notifications: Critical, Major and Normal. Users can click  to pop up the list of Alert and Notifications.

Note that Overview page in addition to other tabs can be updated each 15s, 1min ,2min and 5min or Never by clicking  in the upper bar menu (Default is 15s).

**New Firmware Notification:** Starting from firmware version 1.0.5.13/1.0.5.14, and once a different OFFICIAL firmware is released on Grandstream Networks website, the master AP will popup reminder notification to the administrator in order to upgrade the device. You can click on **New** button in order to be redirected to the release note of the new firmware version, for upgrading steps please refer to section [UPGRADING AND PROVISIONING].

### Save and Apply Changes

When clicking on "Save" button after configuring or changing any option on the web GUI pages. A message mentioning the number of changes will appear on the upper menu. Click  button to apply changes.

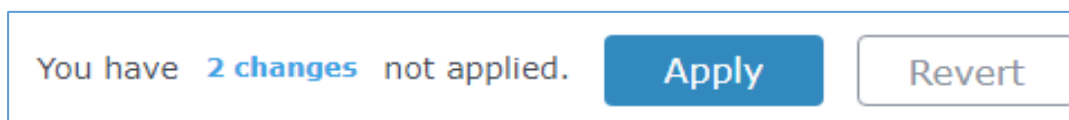


Figure 27: Apply Changes

## GWN MANAGEMENT PLATFORMS

### GWN.Cloud

Starting from firmware 1.0.6.41/1.0.6.43, the GWN76XX can be managed by your **GWN.Cloud** account, **GWN.Cloud** web interface now can be accessed at <https://www.gwn.cloud>.



Figure 28: GWN.Cloud Architecture

### GWN.Manager

Starting from firmware 1.0.13.1, the GWN76XX can be managed and monitored by your **GWN Manager** account, GWN Manager On-premise Access Points Controller platform can be installed using the link below: <https://www.grandstream.com/support/firmware>



Figure 29: GWN Manager Architecture

**Note:** GWN Manager installation is supported on virtual machines (Tested on **VMware** only). Please refer to [GWN Management Platform User Guide](#) for more detailed information.

## USING GWN76XX AS STANDALONE ACCESS POINT

The GWN76XX can be used in Standalone mode, where it can act as Master Access Point Controller or in Slave mode and managed by another GWN76XX Master.

This section will describe how to use and configure the GWN76XX in standalone mode.

### Connect to GWN76XX Default Wi-Fi Network

GWN76XX can be used as standalone access point out of box, or after factory reset with Wi-Fi enabled by default.

After powering the GWN76XX and connecting it to the network, GWN76XX will broadcast a default SSID based on its MAC address **GWN [MAC's last 6 digits]** and a random password.

Note that GWN76XX's default SSID and password information are printed on the MAC tag of the unit as shown on the below figure.

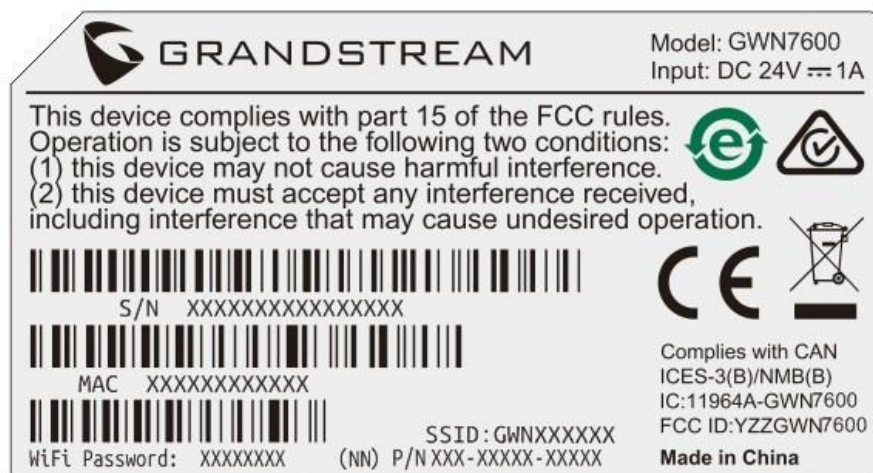


Figure 30: MAC Tag Label



## USING GWN76XX AS MASTER ACCESS POINT CONTROLLER

Master Mode allows a GWN76XX to act as an Access Point Controller managing other GWN76XX access points. This will allow users adding other access points under one controller and managing them in an easy and a centralized way.

Master/Slave mode is helpful with large installations that needs more coverage area zones with the same controller.

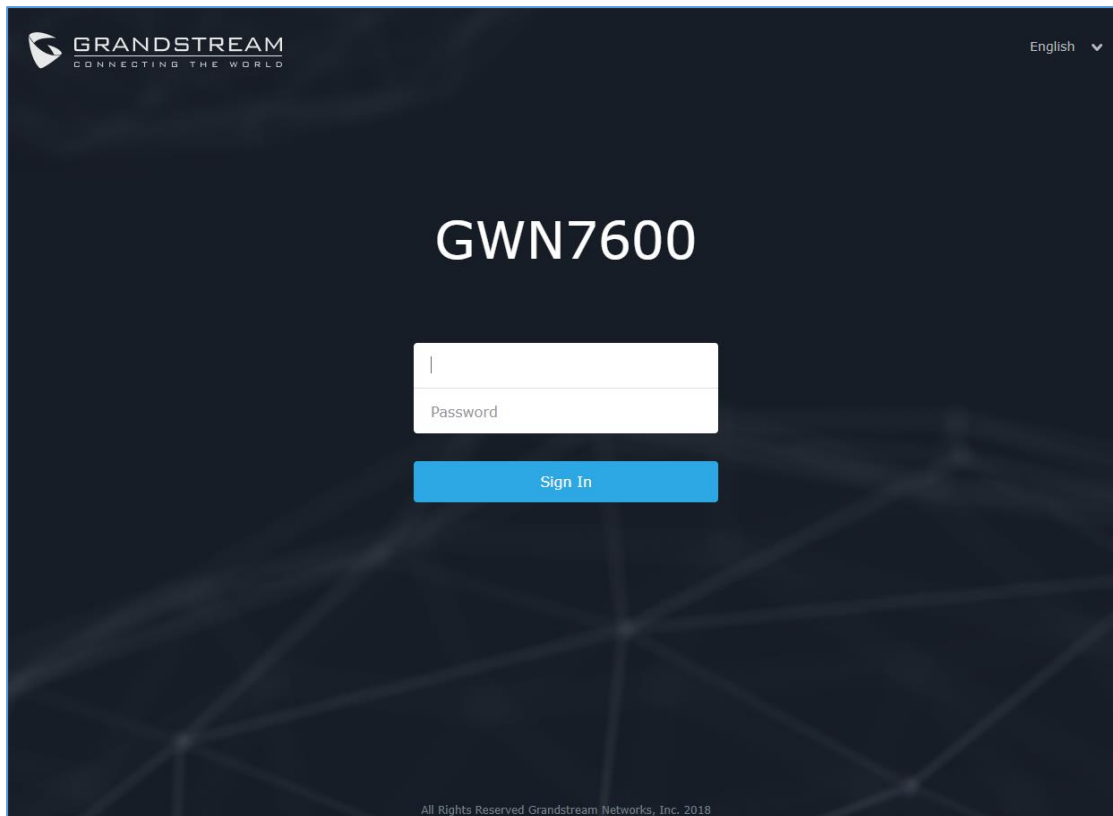


Figure 31: Login Page

---


 **Warning:**

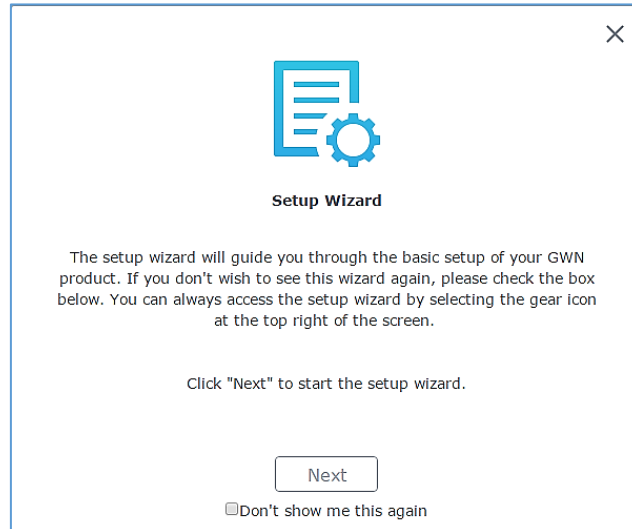
“Set unit as Master” option will forbid the GWN76XX Access Point from being paired by other Master GWN76XX and can only act as a Master Access point controller.

Users will need to perform a factory reset to the GWN76XX , or unpair it from the initial GWN76XX to make it open to Master Access Point mode again.

---

## Login Page

After login, users can use the Setup Wizard tool to go through the configuration setup or exit and configure it manually. Setup Wizard can be accessed anytime by clicking on  while on the web interface.



**Figure 32: Setup Wizard**

## Discover and Pair Other GWN76XX Access Point

First, note that by default the GWN controller access point will automatically discover all APs connected to the same LAN (broadcast domain), but starting from firmware 1.0.5.13/1.0.514 a new possibility has been added in order to pair and provision remote APs using DHCP option 43 with master direction explained below.

### Master Direction

To pair and manage access points located on remote networks, the admin needs to configure the IP address of master AP on DHCP option 43 which will be send to the slave access point during booting stage and allow the save/master connection to be established remotely. GWN76XX accepts option 224 encapsulated in option 43, and the syntax is in TLV format. A simple example of DHCP 43 configuration would be:

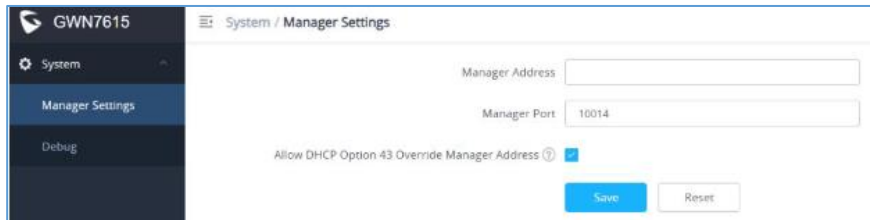
***224(Type)12(Length)10.157.0.234(Value) translated into Hex as e00c31302e3135372e302e323334***

Scenario example: a company has two offices connected via VPN (master AP located on network 192.168.1.0/24 and slave AP located on remote network 192.168.2.0/2). On remote network the admin can set DHCP option 43 using GWN7000 router as following value:

**encap:43,224,"192.168.1.100".**

**Note:**

- The slave AP has the option "Allow DHCP Option 43 to override GWN Manager Address" enabled by default.

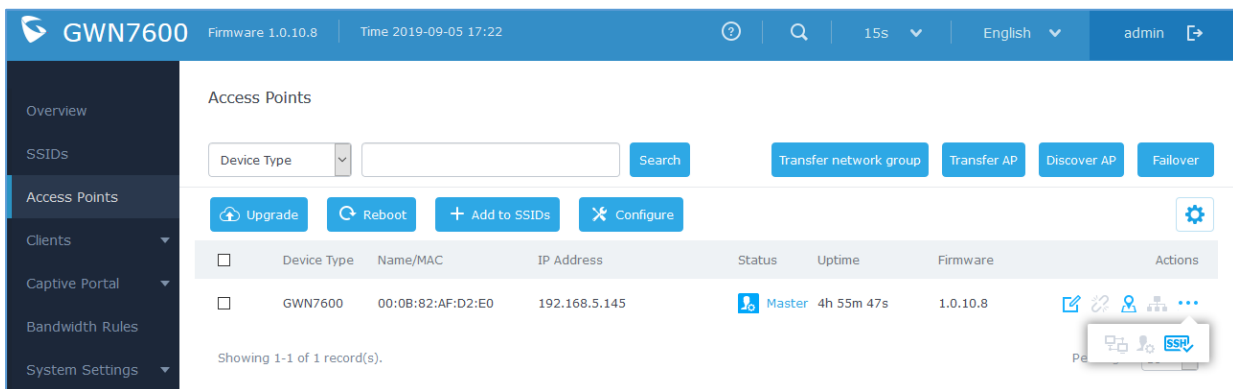


**Figure 33: Option 43 Override**

After that, the slave AP will be listed on the master AP discovered devices and ready for pairing and provisioning process which is described on the next steps.

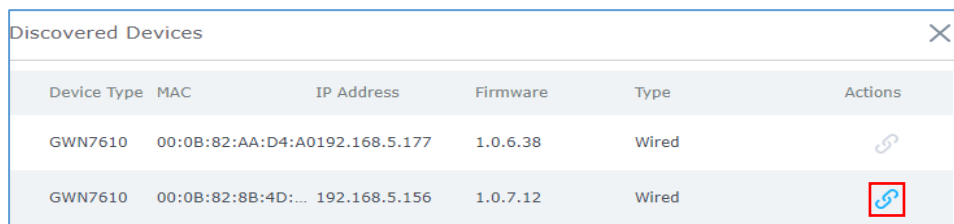
To Pair a GWN76XX access point connected to the same Network as the GWN76XX follows the below steps:

1. Connect to the GWN76XX Web GUI as Master and go to **Access Points**.













**Figure 34: Discover and Pair GWN76XX**

2. Click on [Discover AP](#) to discover access points within GWN76XX Network, the following page will appear.






**Figure 35: Discovered Devices**

- Click on Pair  under Actions, to pair the discovered access point as slave with the GWN76XX acting as Master.
- The paired GWN76XX will appear Online, users can click on  to unpair it.

<input type="checkbox"/>	GWN7600	00:0B:82:AF:D2:E0	192.168.5.145	 Master	23h 46m 46s	1.0.10.8	   
<input type="checkbox"/>	GWN7630	00:0B:82:9A:96:58	192.168.5.121	Online	1h 15m 13s	1.0.10.8	  

**Figure 36: GWN76XX Online**

- Users can click  on next to Master or paired access point to check device configuration for its status, users connected to it and configuration. Refer to below table for Device Configuration tabs.
- Now an easier way to transfer your master authority from one unit to another available unit is available on Access Point management page. By clicking the  then  “**Transfer to Master**” button the designated slave unit will be upgraded to master and current master will be downgraded to slave accordingly.

**Table 16: Device Configuration**

Field	Description
<b>Status</b>	Shows the device’s status information such as MAC, Product Model, Part Number, Boot Version, Firmware version, IP Address, Link Speed, Uptime, and Users count via different Radio channels.
<b>Clients</b>	Shows the connected users to the GWN76XX access point.
<b>Configuration</b>	<ul style="list-style-type: none"> <li><b>Device Name:</b> Set GWN76XX’s name to be shown next to MAC address.</li> <li><b>Fixed IP:</b> Set a static IP for the GWN76XX, default is unchecked.</li> <li><b>Airtime Fairness:</b> Allow faster clients to have more airtime than slower clients. <i>This feature is not supported in GWN7630/7630LR.</i></li> <li><b>Band Steering:</b> When Frequency is set to Dual-Band, users can check this option to enable Band Steering on the Access Point, this will help redirecting clients to 5G band accordingly for efficient use and to benefit from the maximum throughput supported by the client.</li> <li><b>NET Port Type:</b> You can configure Trunk port or Access port. If you chose Access, you also need to specify its VLAN ID. <i>This feature is not supported in GWN7600/7600LR/GWN7610.</i></li> <li><b>Client Steering:</b> This feature will help Wi-Fi client to roam to other APs within same Network. parameters of RSSI Threshold and Client Access Threshold parameters will show up only when Client Steering is enabled. <i>Supported only by GWN7600/7600LR.</i></li> </ul>

- **Channel Width:** Choose the Channel Width, note that wide channel will give better speed/throughput, and narrow channel will have less interference. 20Mhz is suggested in very high-density environment.
- **40MHz Channel Location:** Configure the 40MHz channel location when using 20MHz/40MHz in Channel Width, users can set it to be Secondary below Primary, Primary below Secondary or Auto.
- **Channel:** Select Auto, or a specified channel, default is Auto. Note that the proposed channels depend on **Country** Settings under **System Settings**→**Maintenance**.
- **Enable Short Guard Interval:** Check to activate this option to increase throughput.
- **Radio Power:** Set the Radio Power, it can be Low, Medium or High.
- **Enable Minimum RSSI:** Configures whether to enable/disable Minimum RSSI function.
- **Custom Wireless Power(dBm):** allows users to set a custom wireless power for both 5GHz/2.4GHz band, the value of this field must be between 1 and 31.
- **Allow Legacy Devices(802.11b):** Check to support 802.11b devices to connect the AP in 802.11n/g mode.
- **Dynamic Channel Assignment:** Once enabled, AP will try to allocate and move the best channel during operation, unlike Auto Channel Selection (ACS) which scan and assign channel when Wi-Fi interface goes up for one time.
- **Transmit Power Control:** TPC algorithm runs every 10 minutes. AP acquires the RSSI information of the neighbor by wireless scanning and establishes the neighbor table. The algorithm requires that there must be at least 3 neighbor APs with RSSI larger than -70dbm. Otherwise, power will not be adjusted.
- **Coverage Hole Detection:** CHD enables AP to decide whether to increase the AP power by the current SNR and SNR threshold of the connected clients.

---

**Note**

If a GWN76XX is not being discovered or the pair icon is grey color, make sure that it is not being paired with another GWN76XX Access Point acting as Master Controller.


---




If yes users will need to unpair it first, or reset it to factory default settings in order to make it available for pairing by other GWN76XX Access Point Controller

---

## AP Location

GWN supports a handy feature which allows users to locate other Access points by blinking LED. To use the feature, navigate on the master web GUI under “Access Points” page and click on the icon  near the desired AP, and its corresponding unit will start blinking the LEDs.

## Transfer AP – Transfer Network Group

Users can easily transfer the AP from local master to the **GWN** account by clicking on  . When you already have Network/WIFI configurations on your cloud account, using this feature will let you choose existing Network/SSID to adopt your local AP.

**Note:** Local configurations will not be transferred.



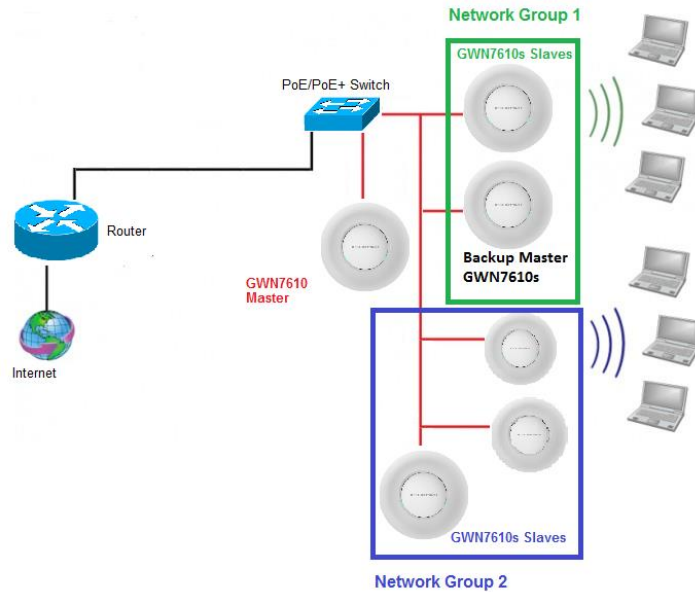
feature will allow you to transfer your local configurations to your cloud account.

For more details, please refer to [GWN.Cloud User Guide](#).

## Failover Master

In a Master-Slave architecture, having a backup Master is critical for redundancy and failover function, thus, and in order to avoid a single point of failure in your wireless network, you can specify a slave AP as failover master. Whenever it detects the master is down, it will promote itself as failover master within a time frame of around 20~30 minutes by entering failover mode. After then, if the master AP comes back, failover master will automatically go back to slave mode, or if the master doesn't come back to alive, Administrator can login using “failover” account to turn the failover master as true master and take over all controls.





**Figure 37: Failover Master**

Users could select the failover Master by following below steps:

- Log into web GUI of the master GWN.
- Go to Access Points page.
- Press **Failover**
- Select from the available paired Slave Aps the candidate to become a failover Master.
- Save and Apply the settings.

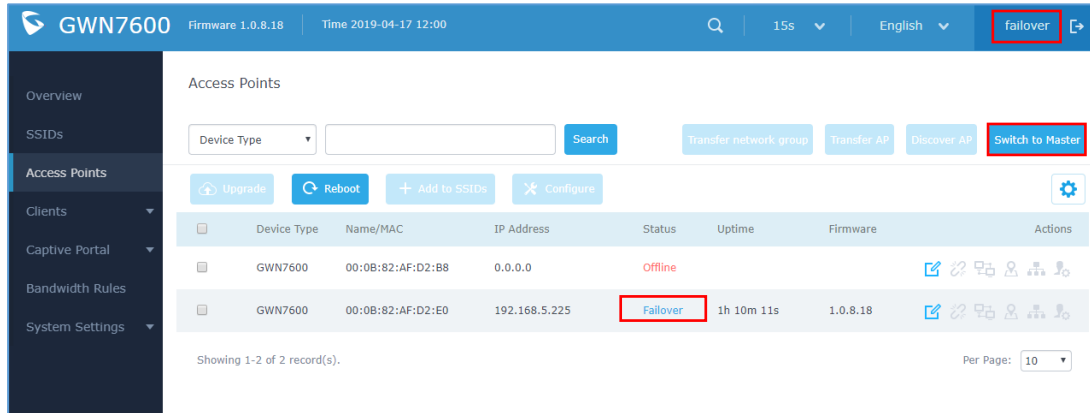
### Failover Mode

Once failover slave has been selected, the primary master will send the configuration of the network to the failover slave and the slave will start monitoring the status of the primary master to detect any failure for any reason (network connection loss, power outage).

In case of failure, the failover slave will promote itself to a temporary backup master while waiting for the primary master to come back.

During the failover mode users could access the web GUI of the failover slave using a special failover account with same admin password.

- **Username = failover**
- **Password = admin password**



**Figure 38: Failover Mode GUI**

The failover mode has only read permission on the configuration and very limited options, users still can reboot other slave Access points in case it is needed.

Users also can press on « **Switch to Master** » button in order to set the failover slave as the new primary master of the wireless network, once this is done they have full write permission control over the web GUI option as usual. Use that button to switch to master and takeover the rest of the APs.

#### Important notes:

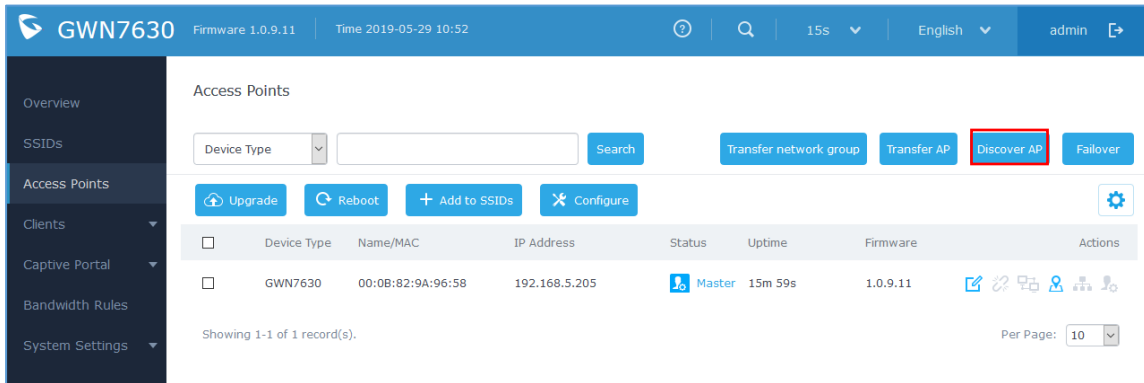
- If you click « **Switch to Master** », this would be become a non-revertible behavior. Failover Slave will become actual master and the prior master can't take back the control anymore.
- When Failover Slave is switched to Master, you will use the Prior Master AP credentials: username: admin, and the admin password.
- Otherwise, when original master comes back online, then Failover Slave will become slave again to prior original Master.

## Takeover Feature

This feature is used to re-pair the slave APs whose master has gone offline with another master AP in the same subnet. Please follow the steps to takeover slave APs from other master:

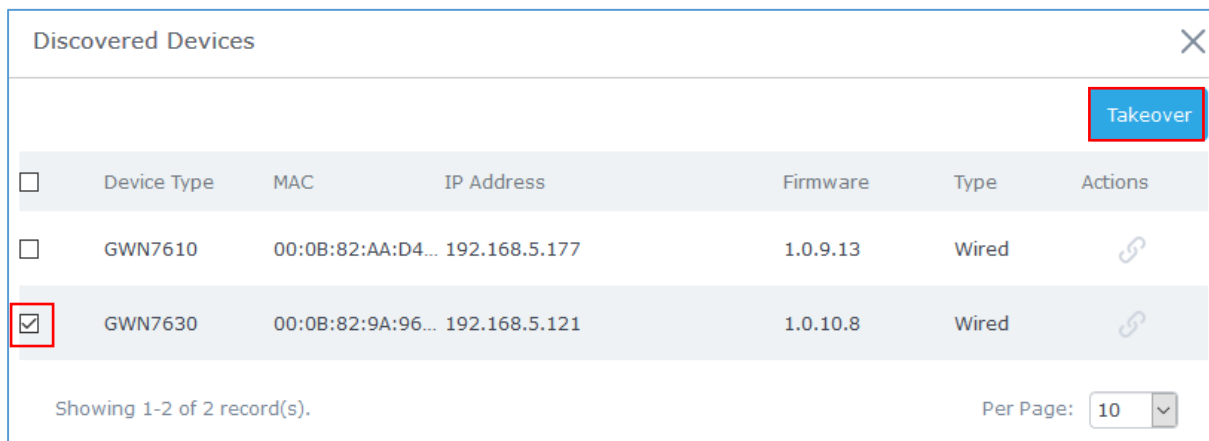
**Step 1.** Login to the Web GUI of Master and click on “Discover APs” in the Access Points Page.





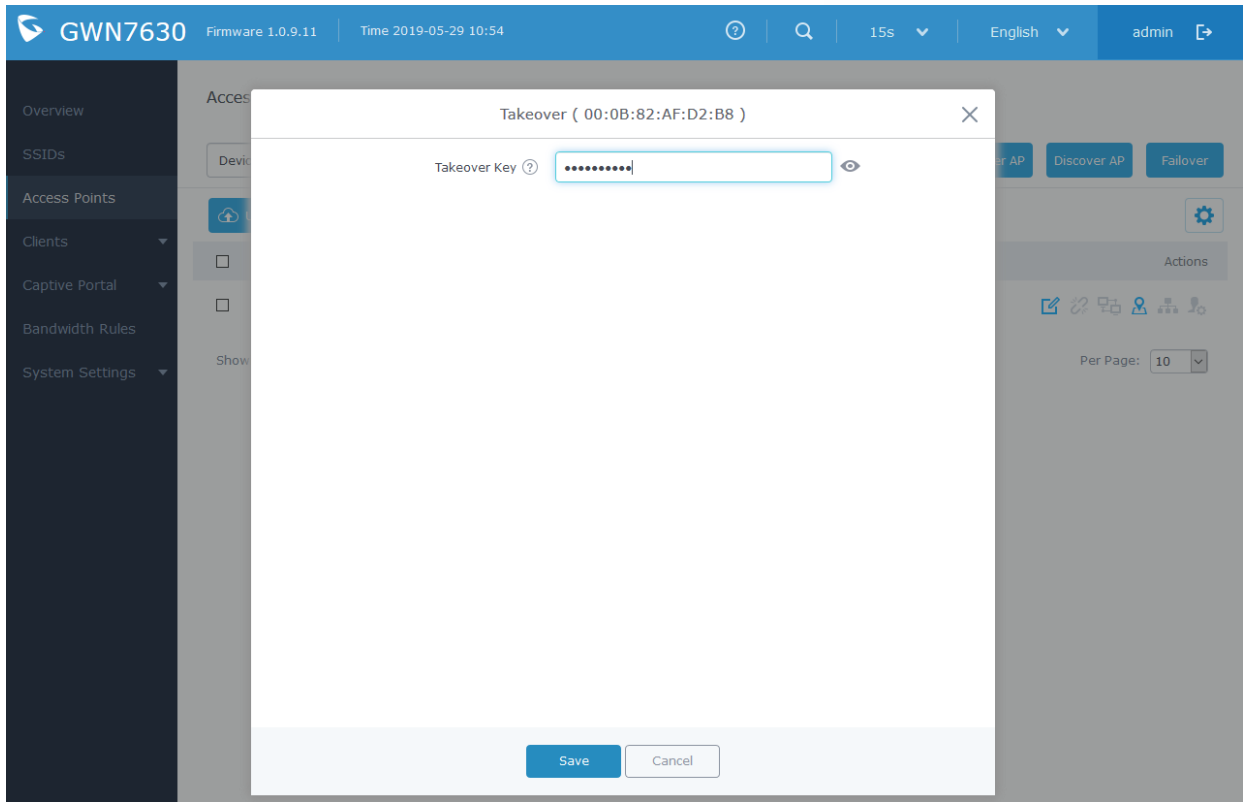
**Figure 39: Takeover - Step 1**

**Step 2.** Select the one or multiple APs to be taken over then click on “takeover” button of the target AP.



**Figure 40: Takeover - Step 2**

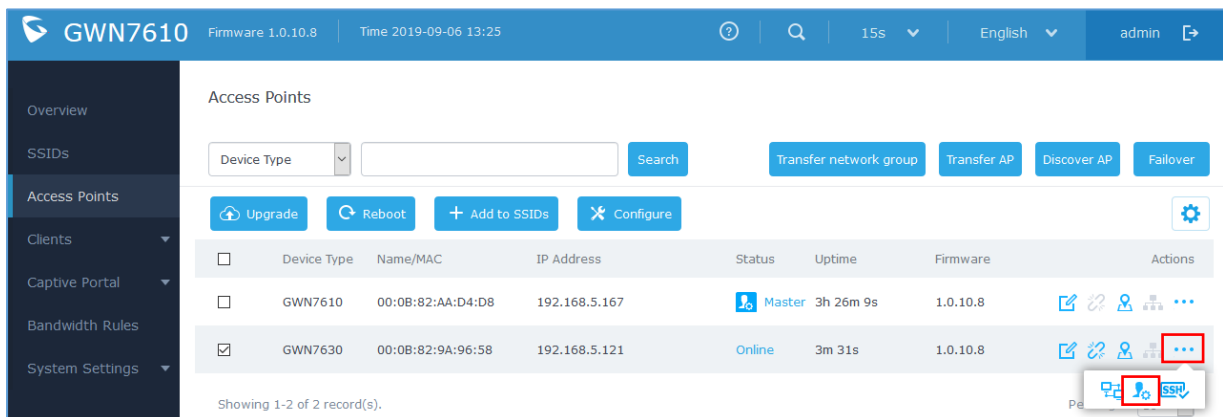
**Step 3.** Enter the Takeover key which is the admin password of the previous master AP.



**Figure 41: Takeover - Step 3**

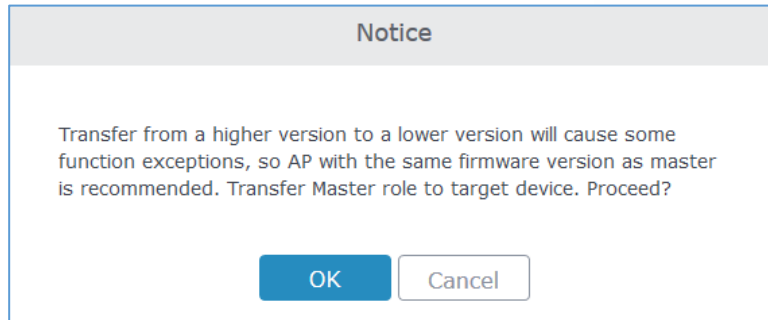
## Transfer to Master

From the Master Access Point, the Administrator do have the capability to assign any Slave Access point to become the new Master to manage all the already paired Access points.



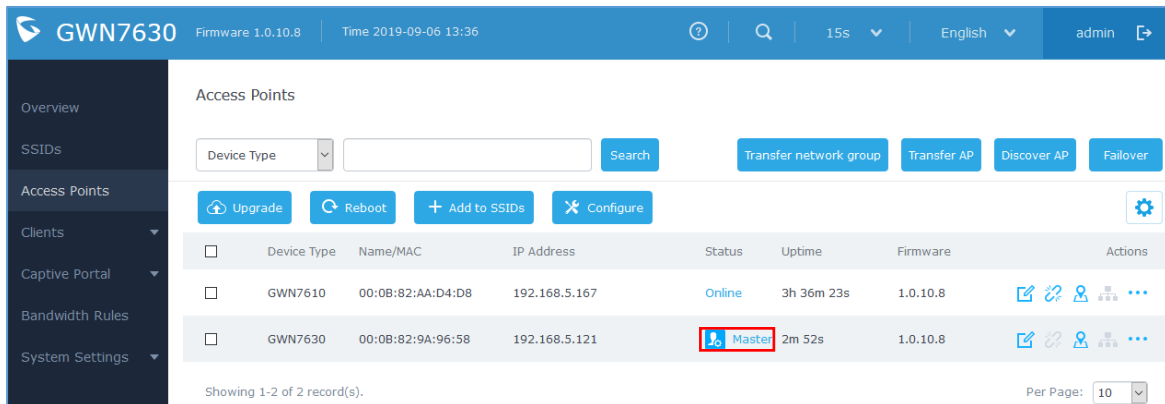
**Figure 42: Switch to Master**

After you click on **...** then press the “Switch to Master” button, the following warning message will prompt in order to confirm the procedure:



**Figure 43: Transfer Master Role to another device confirmation message**

When the process is finished, the original Master will turn to be a slave for the new Assigned Master, and to login to the new Master AP web interface, you will need to use the previous Master Admin password.





**Figure 44: Then new assigned Master AP web interface**

**Note:**





- All the previously existed paired APs will be provisioned with the new Master AP.
- The Switch to Master option is unlimited action and doesn't require any reset for the already paired Aps.

## Client Bridge

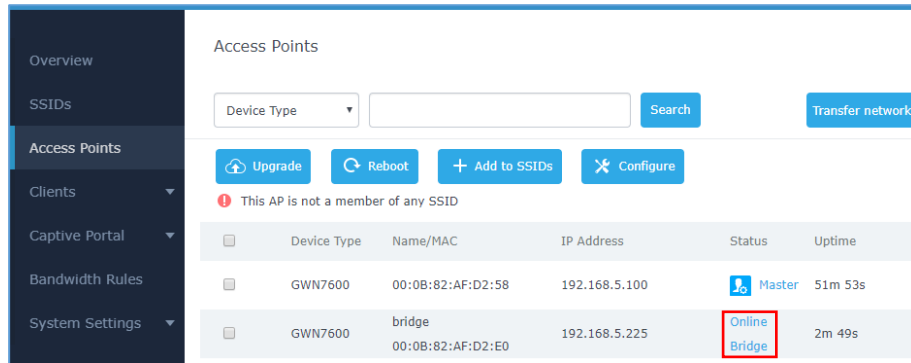
The Client Bridge feature allows an access point to be configured as a client for bridging wired only clients wirelessly to the network. When an access point is configured in this way, it will share the Wi-Fi connection to the LAN ports transparently. This is not to be confused with a mesh setup. The client will not accept wireless clients in this mode.

Once a SSID has the Client Bridge Support enabled, the AP adopted in this SSID can be turned in to Bridge Client mode by click the  then the Bridge button .

Please be noted that once an AP it turned into Client Bridge mode, it cannot be controlled by a Master anymore, and a factory reset is required to turn it back into normal AP mode.

<input type="checkbox"/>	GWN7610	00:0B:82:8B:4E:28	192.168.6.37	Online	1.0.3.21	   
--------------------------	---------	-------------------	--------------	--------	----------	---

**Figure 45: Client Bridge**



Access Points

Device Type  Search Transfer network

Upgrade Reboot + Add to SSIDs ✖ Configure

! This AP is not a member of any SSID

<input type="checkbox"/>	Device Type	Name/MAC	IP Address	Status	Uptime
<input type="checkbox"/>	GWN7600	00:0B:82:AF:D2:58	192.168.5.100	Master	51m 53s
<input type="checkbox"/>	GWN7600	bridge 00:0B:82:AF:D2:E0	192.168.5.225	Online Bridge	2m 49s

**Figure 46: Client Bridge**

In order to verify, you may access the bridged AP configuration, then under **Status**, the option “Client Bridge Mode” would be set to **Isolated** like shown on the figure down below:

SSID	GWNAFD258, bridge
IP Address	192.168.5.225
Uptime	4m 29s
Client Bridge Mode	Isolated

**Figure 47: Client Bridge Mode**

**Important Notes :**

- The access point that will be operating on bridge mode, must be set with a fixed IP address before activating the bridge mode on the access point.
- Users must enable client bridge support option under SSID or SSID Wi-Fi settings in order to have it fully functional.
- The Client Bridge requires the SSID to not have any VLAN ID enabled.

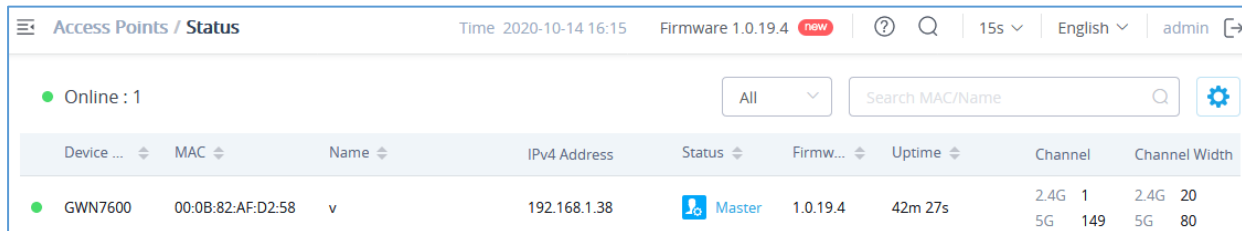
## ACCESS POINTS

From the access points page, the administrator can monitor different information regarding the access points of the selected network, this section is separated into 3 sub-sections:

1. Status
2. Configuration

### Status




The Status page lists all the access points assigned to the selected network, along with the possibility to perform some basic operations such locating the device (LEDs start blinking in White) or clear the usage data, also users can check more detailed information about each access point and benefit from useful debugging tools which can help diagnose issue when they appear.



Device ...	MAC	Name	IPv4 Address	Status	Firmw...	Uptime	Channel	Channel Width
GWN7600	00:0B:82:AF:D2:58	v	192.168.1.38	Master	1.0.19.4	42m 27s	2.4G 1 5G 149	2.4G 20 5G 80

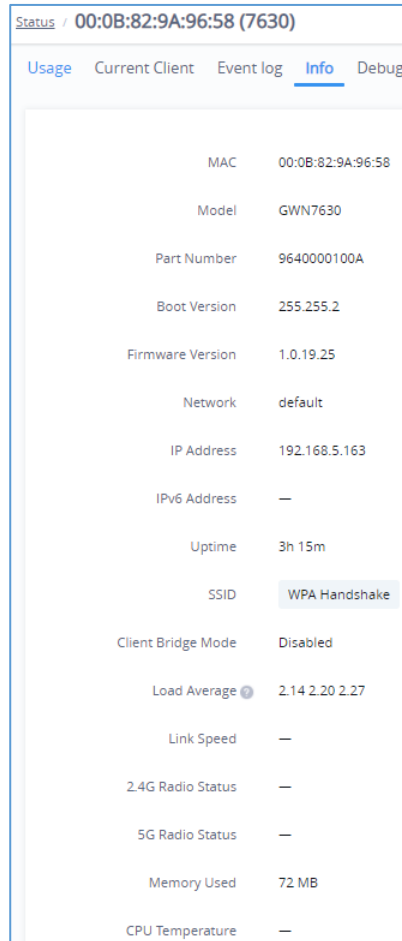
**Figure 48: Access Points - Status**

**Table 17: Access Points Status Parameters**

<b>Model</b>	GWN Access Point Model: GWN7610, GWN7600, GWN7600LR or GWN7630 (Beta)
<b>MAC</b>	MAC Address of the Access Point
<b>Name</b>	Access Point's name
<b>IP Address</b>	IP Address of the Access point
<b>Firmware</b>	Firmware of the Access point
<b>Uptime</b>	Uptime of the Access point
<b>Channel</b>	Channels used by this Access points for both 2G and 5G.
<b>Client</b>	Number of clients connected to the Access Point
<b>Actions</b>	Locate Access point using  button. Press  to clear access point usage. Press  to switch slave access point to become master.

To get more detailed information about the status of a specific access point, users can click on the desired AP then a page similar to the following will show up:

The next tab “Info” shows detailed information about the select AP, such as the model, name, firmware version, memory used and which SSID is being broadcasted by this AP and more.



**Figure 49: AP Info**

The first tab will display the data usage for the specified access point and allows the user to filter the traffic graph for the last 2hours, 1day, 1week or 1 month. Also, the user has the ability to visualize the data usage (Upload/Download) for all SSIDs broadcasted by the AP or select a specific SSID from the drop-down list.

Click on Current clients to see the currently connected clients to the select AP as shown on the figure below.

MAC	Name	IP Address	Channel	Total	Upload	Download	RSSI
B4:BF:F6:40:DF:3B	Galaxy-J7-Pro	192.168.1.68	5G 40	140.06 MB	3.4 MB	136.65 MB	40
D4:E6:B7:B2:D0:B1	Galaxy-A8-2018	192.168.1.56	5G 40	214.07 KB	92.27 KB	121.79 KB	14
E4:A7:C5:18:D3:03	HUAWEI_Mate_10_lite-51297	192.168.1.12	2.4G 6	73.24 MB	1.94 MB	71.3 MB	51
F0:79:E8:5D:99:AF	android-250dd9c93fe7ac6c	192.168.1.189	2.4G 6	141.33 MB	5.79 MB	135.54 MB	46

**Figure 50: Current Clients - Stats per AP**



The last Tab is used by administrator for debugging purposes and provides the following tools:

- **Ping/Traceroute** tools, such as the **ping** utility, **traceroute** tool.
- **One Key Debugging**, to capture Wireless, Portal or Mesh traffic and logs will be found in Core Files.
- **Core Files**, when a crash event happens on the unit, it will automatically generate a core dump file that can be used by engineering team for debugging purposes.

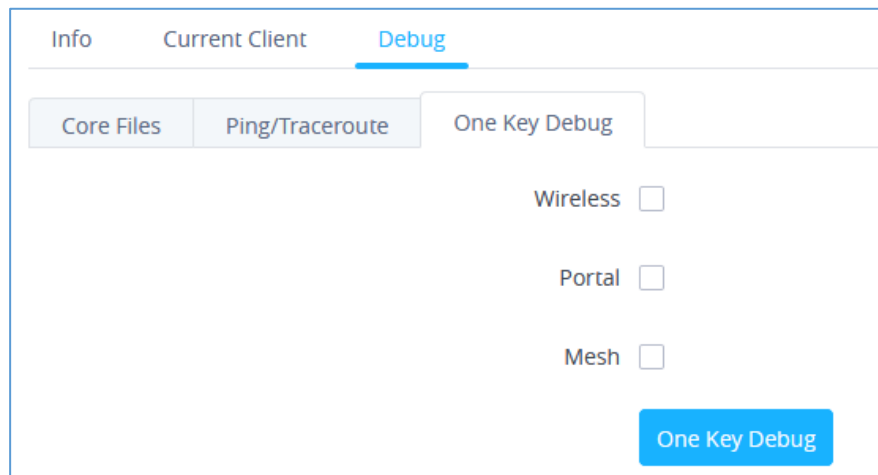


Figure 51: Debug Tool Tab

## Configuration

The configuration page allows the administrator to add, move, delete, reboot, configure or reset access points.

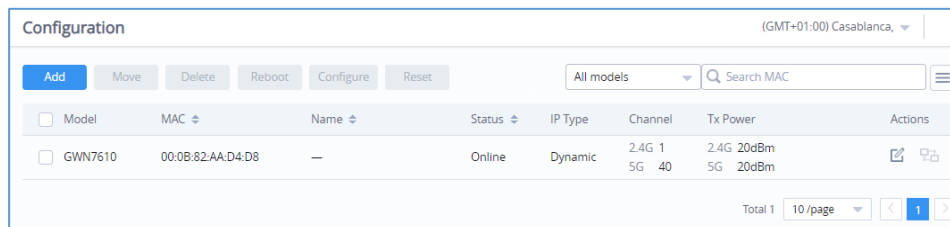


Figure 52: Access Points Configuration Page

### Add New Access Points

- There are two methods to add new access points, either manually or using GWN Cloud App.
- Please refer to [\[Adopt GWN76XX to GWN Manager\]](#) section in this manual.

## Move Access Points

The administrator can move GWN Access points from one network to another. Click on Move button and the following window will popup, select the network where to move the access point and click on move.

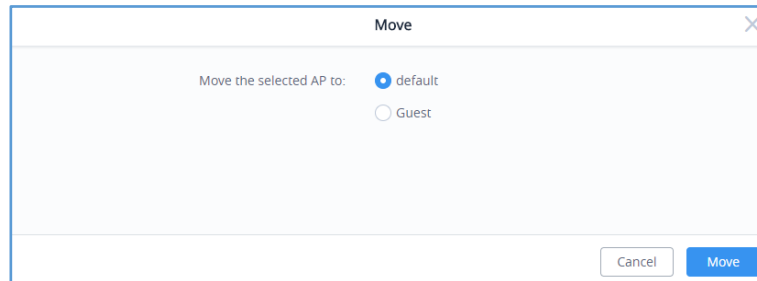


Figure 53: Moving Access Points between Networks

## Delete Access Points

To delete an access point, select it, then click on reboot button, the following confirmation message will be displayed:

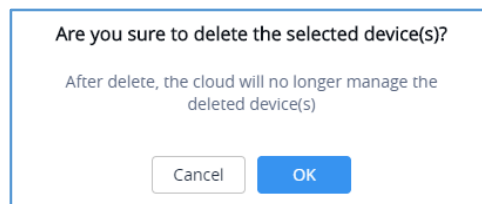


Figure 54: Delete Access Point

## Reboot Access Points

To reboot an Access point, select it then click on Reboot button, the below confirmation message will be displayed:

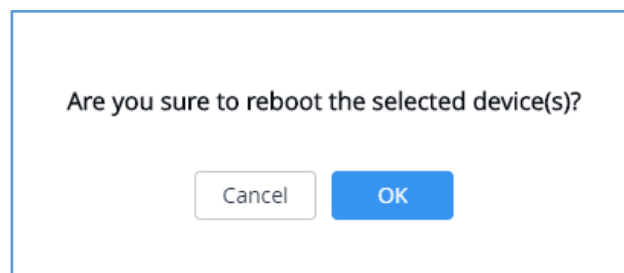
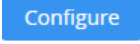
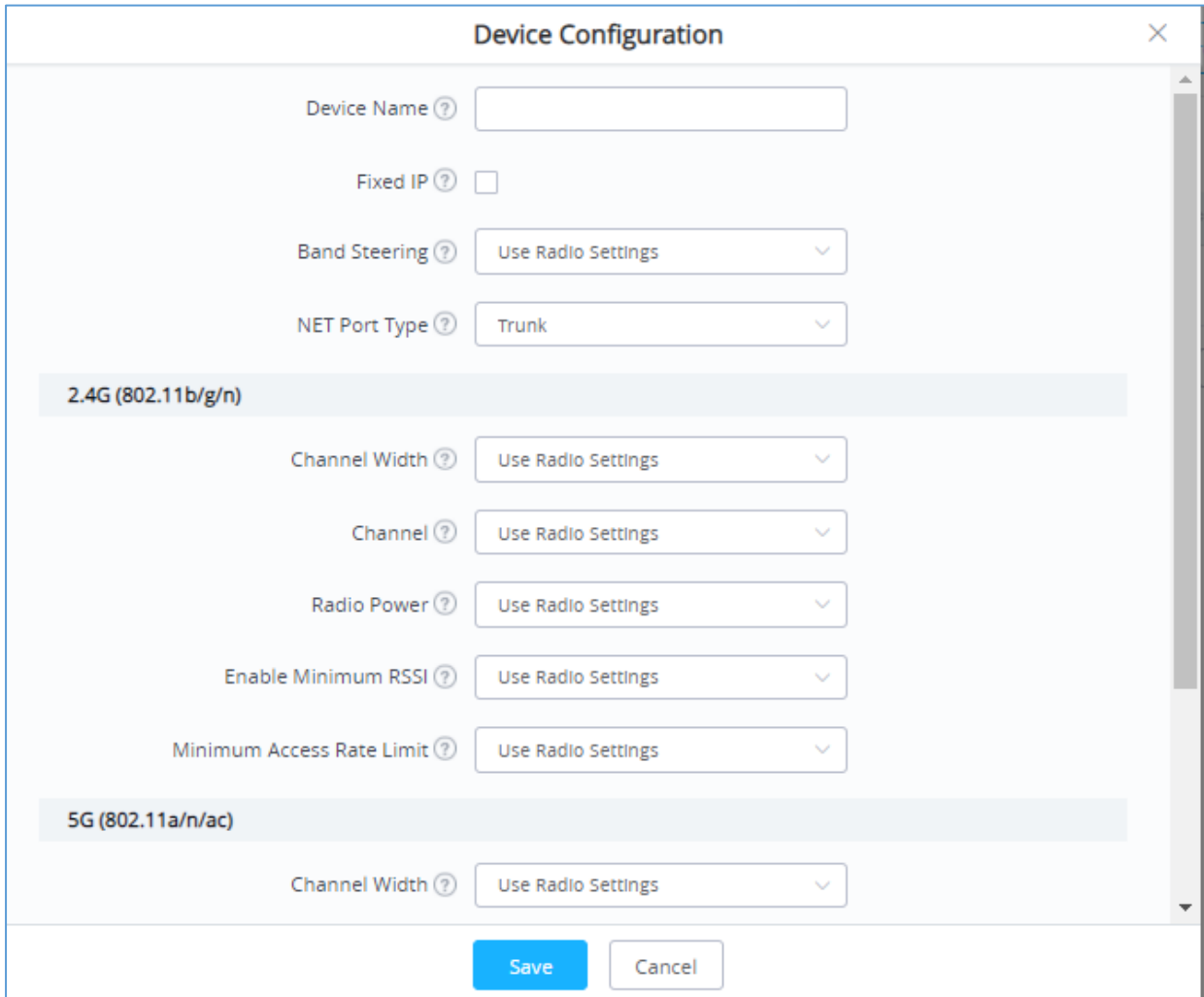


Figure 55: Reboot Access Point

## Configure Access Points

To configure an access point, select and click on  button. A new config page will popup:





**Figure 56: Access Point Configuration Page**

The following settings can be configured from this page:

**Table 18: Access Point Configuration Settings**

<b>Device Name</b>	Set GWN76xx's name to identify it along with its MAC address.
<b>Fixed IP</b>	Check this option to configure the device with a static IP configuration; it must be in the same subnet with the default Network Group; Once enabled, these fields will show up: IPv4 Address/IPv4 Subnet Mask/IPv4 Gateway/Preferred IPv4 DNS/Alternate IPv4 DNS.
<b>Band Steering</b>	<p>Band Steering will help redirecting clients to a radio band 2.4G or 5G, depend on what's supported by the device, for efficient use and to benefit from the maximum throughput. Four options are allowed by GWN.Cloud:</p> <ul style="list-style-type: none"> <li>• <b>Disable Band steering:</b> This will disable the band steering feature and the access point will accept the band chosen by the client.</li> </ul>

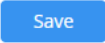


	<ul style="list-style-type: none"> <li>• <b>2G in Priority:</b> 2G Band will be prioritized over 5G Band</li> <li>• <b>5G in Priority:</b> 5G Band will be prioritized over 2G Band</li> <li>• <b>Balance:</b> GWN will balance between the clients connected to 2G and those connected to 5G.</li> <li>• <b>Use Radio Settings:</b> GWN will use the value configured under Radio page.</li> </ul>
<b>Net Port Type</b>	<p>You can configure Trunk port or Access port. When it's set to Access, you also need to specify the VLAN ID.</p> <p>For example, if you have multiple SSIDs on different VLANs, then the port need to be set to Trunk in order to negotiate trunk with the switch port where the AP is plugged. Otherwise if there is only one SSID/VLAN the port type is set to Access.</p> <p><i>This feature is not supported in GWN7600/7600LR/GWN7610.</i></p>
<b>Wi-Fi5 Compatible Mode</b>	<p>Some old devices do not support Wi-Fi6 well, and may not be able to scan the signal or connect poorly. After turning on this switch, it will switch to Wi-Fi5 mode to solve the compatibility problem. At the same time, it will turn off Wi-Fi6 related functions. Default is "Use Radio Settings", the AP then will use the value configured under Radio page.</p> <p><i>This feature is only supported in GWN7660.</i></p>
<b>2.4G &amp; 5G</b>	Used for configuring the advanced settings for 2.4G & 5G.
<b>Channel Width</b>	<ul style="list-style-type: none"> <li>• Choose the Channel Width, note that wide channel will give better speed/throughput, and narrow channel will have less interference. 20Mhz is suggested in very high-density environment. Default is "Use Radio Settings", the AP then will use the value configured under Radio page.</li> </ul>
<b>Channel</b>	Select Use Radio Settings, or a specified channel, default is Auto. Note that the proposed channels depend on Country Settings under System Settings→Maintenance. Default is "Use Radio Settings", the AP then will use the value configured under Radio page.
<b>Radio Power</b>	Set the Radio Power depending on desired cell size to be broadcasted, five options are available: "Low", "Medium", "High", "custom" and "Use Radio Settings". Default is "Use Radio Settings", the AP then will use the value configured under Radio page.
<b>Custom 2.4GHz/5GHz Tx Power (dBm)</b>	When Radio Power is set to "Custom", allow users to set a custom wireless power for both 5GHz/2.4GHz band, the value of this field must be between 1 and 31.

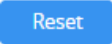



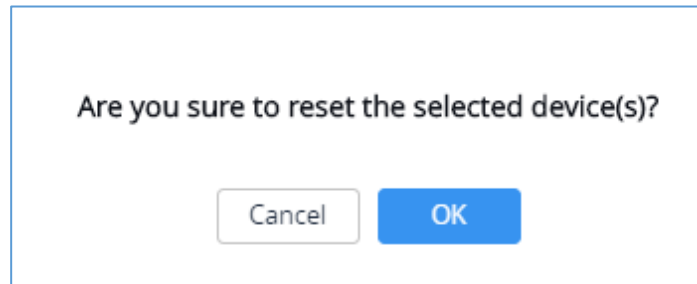
<b>Enable Minimum RSSI</b>	Configures whether to enable/disable Minimum RSSI function. This option can be either Disabled, or Enabled and set manually or set to Use Radio Settings.
<b>Minimum Access Rate Limit</b>	Specify whether to limit the minimum access rate for clients. This function may guarantee the connection quality between clients and AP. This option can be either Disabled, or Enabled and set manually or set to Use Radio Settings.

**Notes:**

- The administrator can filter access points by Model or search by name/MAC of the device.
- Click on  Button to save the changes and apply them to the AP.

**Reset Access Points**

To reset an access point, select and click on  button, a confirmation message will be displayed, click on  to confirm the operation.

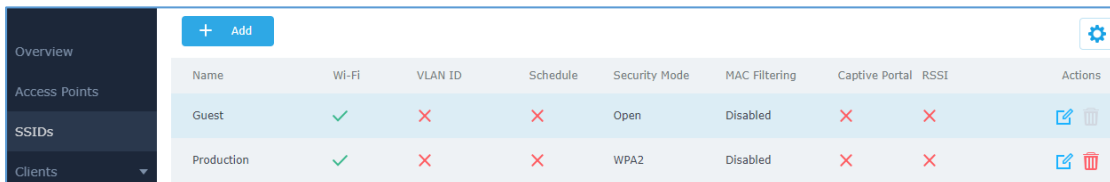


**Figure 57: Reset Access Point**

## SSIDs

When using GWN76XX as Master Access Point, users can create different SSIDs and assign GWN76XX Slave Access Points to them.

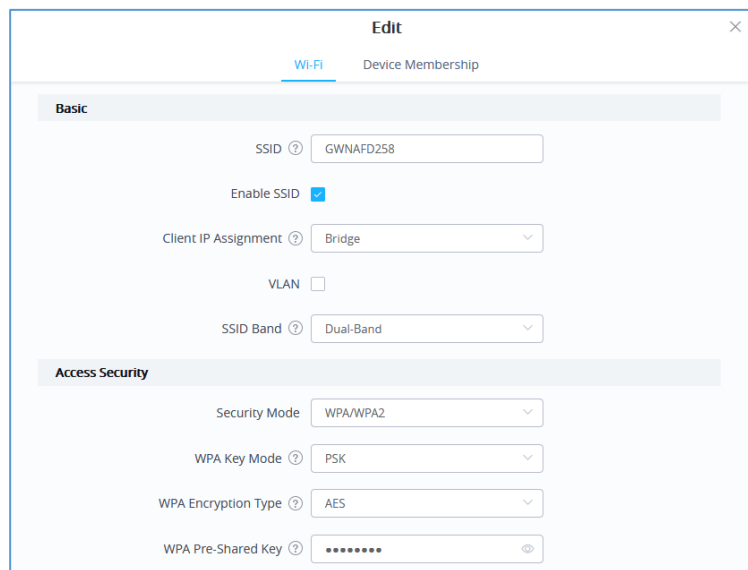
Log in as Master to the GWN76XX WebGUI and go to **SSIDs**.



Name	Wi-Fi	VLAN ID	Schedule	Security Mode	MAC Filtering	Captive Portal	RSSI	Actions
Guest	✓	✗	✗	Open	Disabled	✗	✗	[Edit] [Delete]
Production	✓	✗	✗	WPA2	Disabled	✗	✗	[Edit] [Delete]

**Figure 58: SSIDs**

GWN7660 can support up to 32 SSIDs like GWN7630LR/ GWN7630/ GWN7615/ GWN7610/ GWN7600/GWN7600LR while the other models including GWN7605/GWN7605LR can support up to 16 SSIDs, and GWN7602 can support up to 8 SSIDs, click on **+ Add** to add a new SSID.



**Figure 59: Add a new SSID**

When editing or adding a new SSID, users will have two tabs to configure:

- **Wi-Fi:** Please refer to the below table for Wi-Fi tab options

**Table 19: Wi-Fi**

Field	Description
<b>SSID</b>	Set or modify the SSID name.
<b>Enable SSID</b>	Check to enable Wi-Fi for the SSID.
<b>Client IP Assignment</b>	Set to NAT mode, clients will get the IP addresses from the specified NAT pool. And clients connecting to different APs are isolated from each other.

	<i>This feature is not supported in GWN7610.</i>
<b>SSID Band</b>	Select the Wi-Fi band the GWN will use, three options are available: <ul style="list-style-type: none"> <li>• <b>Dual-Band</b></li> <li>• <b>2.4GHz</b></li> <li>• <b>5Ghz</b></li> </ul>
<b>VLAN</b>	Enter the VLAN ID corresponding to the SSID. <i>This is available when Client IP Assignment is set to Bridge.</i>
<b>Security Mode</b>	Set the security mode for encryption, 8 options are available: <ul style="list-style-type: none"> <li>• <b>WEP 64-bit:</b> Using a static WEP key. The characters can only be 0-9 or A-F with a length of 10, or printable ASCII characters with a length of 5.</li> <li>• <b>WEP 128-bit:</b> Using a static WEP key. The characters can only be 0-9 or A-F with a length of 26, or printable ASCII characters with a length of 13.</li> <li>• <b>WPA/WPA2:</b> Using “PSK” or “802.1x” as WPA Key Mode, with “AES” or “AES/TKIP” Encryption Type.</li> <li>• <b>WPA2:</b> Using “PSK” or “802.1x” as WPA Key Mode, with “AES” or “GCMP-128” Encryption Type.</li> <li>• <b>WPA2/WPA3:</b> Using “SAE-PSK” or “802.1x” as WPA Key Mode, with “AES” or “GCMP-128” Encryption Type.</li> <li>• <b>WPA3:</b> Using “SAE” or “802.1x” as WPA Key Mode, with “AES” or “AES/TKIP” Encryption Type.</li> <li>• <b>WPA3-192:</b> Using “802.1x” as WPA Key Mode, with “GCMP-256” or “CCMP-256” Encryption Type.</li> <li>• <b>OSEN:</b> This mode is used with release 2 of Hotspot 2.0 Release 2 OSU (Online Signup Server) for client provisioning.</li> <li>• <b>Open:</b> No password is required. Users will be connected without authentication. Not recommended for security reasons.</li> </ul> <p><b>Note:</b> GWN products support for 802.1x (PEAP-MSCHAPv2 and EAP-TLS) requires external AAA server to permit authentication and centralized access management.</p>
<b>WEP Key</b>	Enter the password key for WEP protection mode. <i>This field is available only when “Security Mode” is set to “WEP 64-bit” or “WEP 128-bit”.</i>



<b>WPA Key Mode</b>	<p>Two modes are available:</p> <ul style="list-style-type: none"> <li>• <b>PSK:</b> Use a pre-shared key to authenticate to the Wi-Fi.</li> <li>• <b>802.1X:</b> Use a RADIUS server to authenticate to the Wi-Fi.</li> </ul> <p><i>This field is available only when "Security Mode" is set to "WPA/WPA2", "WPA2", "WPA2/WPA3", "WPA3" or "WPA3-192".</i></p>
<b>WPA Encryption Type</b>	<p>Two modes are available:</p> <ul style="list-style-type: none"> <li>• <b>AES:</b> This method changes dynamically the encryption keys making them nearly impossible to circumvent.</li> <li>• <b>AES/TKIP:</b> use both Temporal Key Integrity Protocol and Advanced Encryption Standard for encryption, this provides the most reliable security.</li> </ul> <p><i>This field is available only when "Security Mode" is set to "WPA/WPA2", "WPA2", "WPA2&amp;WPA3", "WPA3" or "WPA3-128".</i></p>
<b>WPA Pre-Shared Key</b>	<p>Set the access key for the clients, and the input range should be: 8-63 ASCII characters or 8-64 hex characters.</p> <p><i>This field is available only when "Security Mode" is set to "WPA/WPA2", "WPA2", "WPA2/WPA3" or "WPA3".</i></p>
<b>802.11w</b>	<p>The 802.11w standard is used to prevent certain types of WLAN DoS attacks. 802.11w extends strong cryptographic protection and provides data integrity and replay protection for broadcast/multicast Robust management frames. Set this option to either to Disabled: disable 802.11w; Optional: both of the client supported and unsupported 802.11w may have the network access authority; Required: only the client supported 802.11w have the network access authority.</p>
<b>RADIUS Sever Address</b>	<p>Configures RADIUS authentication server address.</p> <p><i>This field is available only when "WPA Key Mode" is set to "802.1x".</i></p>
<b>RADIUS Server Port</b>	<p>Configures RADIUS Server Listening port. Default is: 1812.</p> <p><i>This field is available only when "WPA Key Mode" is set to "802.1x".</i></p>
<b>RADIUS Server Secret</b>	<p>Enter the secret password for client authentication with RADIUS server.</p> <p><i>This field is available only when "WPA Key Mode" is set to "802.1x".</i></p>
<b>Secondary RADIUS Server</b>	<p>Check the box to enable settings a secondary RADIUS server. Then you need to specify below three fields:</p> <ul style="list-style-type: none"> <li>- <b>RADIUS Server Address:</b> Enter the secondary RADIUS server address.</li> <li>- <b>RADIUS Server Port :</b> Enter the secondary RADIUS server port. <i>The default port is 1812 and the range is 1-65535.</i></li> <li>- <b>RADIUS Server Secret:</b> Enter the secret password for client authentication with the secondary RADIUS server.</li> </ul>



<b>RADIUS Accounting Server</b>	Configures the address for the RADIUS accounting server. <i>This field is available only when "WPA Key Mode" is set to "802.1x".</i>
<b>RADIUS Accounting Server Port</b>	Configures RADIUS accounting server listening port. Default is 1813. <i>This field is available only when "WPA Key Mode" is set to "802.1x".</i>
<b>RADIUS Accounting Server Secret</b>	Enter the secret password for client authentication with RADIUS accounting server. <i>This field is available only when "WPA Key Mode" is set to "802.1x".</i>
<b>Secondary RADIUS Accounting Server</b>	Check the box to enable settings a secondary RADIUS accounting server. Then you need to specify below three fields: <ul style="list-style-type: none"> <li>- <b>RADIUS Accounting Server Address:</b> Enter the secondary Accounting RADIUS server address.</li> <li>- <b>RADIUS Accounting Server Port:</b> Configures the secondary RADIUS accounting server listening port. Default is 1813.</li> <li>- <b>RADIUS Accounting Server Secret:</b> Enter the secret password for client authentication with the secondary RADIUS accounting server</li> </ul>
<b>RADIUS NAS ID</b>	Enter the RADIUS NAS ID. <i>This field is available only when "WPA Key Mode" is set to "802.1x".</i>
<b>Enable Captive Portal</b>	Click on the checkbox to enable the captive portal feature.
<b>Use MAC Filtering</b>	Choose Blacklist/Whitelist to specify MAC addresses to be excluded /included from connecting to the zone's Wi-Fi. Default is Disabled.
<b>Enable Dynamic VLAN (beta)</b>	When enabled, clients will be assigned IP address from corresponding VLAN configured on the RADIUS user profile. <i>This field is available only when "WPA Key Mode" is set to "802.1x".</i>
<b>Client Isolation</b>	Client isolation feature blocks any TCP/IP connection between connected clients to GWN76XX's Wi-Fi access point. Client isolation can be helpful to increase security for Guest networks/Public Wi-Fi. Three modes are available: <ul style="list-style-type: none"> <li>• <b>Radio:</b> Wireless clients can access to the internet services, GWN7xxx router and the access points GWN76XX but they cannot communicate with each other.</li> <li>• <b>Internet:</b> Wireless clients will be allowed to access only the internet services and they cannot access any of the management services, either on the router nor the access points GWN76XX.</li> <li>• <b>Gateway MAC:</b> Wireless client scan only communicate with the gateway, the communication between clients is blocked and they cannot access any of the management services on the GWN76XX access points.</li> </ul>



<b>Advanced</b>	
<b>SSID Hidden</b>	Select to hide SSID. SSID will not be visible when scanning for Wi-Fi, to connect a device to hidden SSID, users need to specify SSID name and authentication password manually.
<b>DTIM Period</b>	<p>Configures the frequency of DTIM (Delivery Traffic Indication Message) transmission per each beacon broadcast. Clients will check the AP for buffered data at every configured DTIM Period. You may set a high value for power saving consideration.</p> <ul style="list-style-type: none"> <li>• Default value is 1, meaning that AP will have DTIM broadcast every beacon.</li> <li>• If set to 10, AP will have DTIM broadcast every 10 beacons.</li> </ul> <p>Valid range: 1 – 10.</p>
<b>Wireless Client Limit</b>	Configure the limit for wireless client. If there's an SSID per-radio on a LAN, each SSID will have the same limit. So setting a limit of 50 will limit EACH ssid to 50 users independently. Note: If set to 0, it equals disable the limit.
<b>Client Inactivity Timeout(s)</b>	AP will remove the client's entry if the client generates no traffic at all for the specified time period. The client inactivity timeout is set to 300 seconds by default. Range from 60-3600 seconds.
<b>Client Bridge Support</b>	<p>Configures the client bridge support to allow the access point to be configured as a client for bridging wired only clients wirelessly to the network. When an access point is configured in this way, it will share the Wi-Fi connection to the LAN ports transparently.</p> <p>Once an SSID has Client Bridge Support enabled, the AP adopted in this SSID can be turned in to Bridge Client mode by click the Bridge button.</p> <p><b>Note:</b> This feature isn't supported on GWN7602.</p>
<b>Client Time Policy</b>	Select a time policy to be applied to all clients connected to this SSID.
<b>Multicast/Broadcast Suppression</b>	<p>When set to "Disable": all of the broadcast and multicast packages will be forwarded to the wireless interface.</p> <p>When set as "Enabled": all of the broadcast and multicast packages will be discarded except DHCP/ARP/IGMP/ND;</p> <p>When set to "Enable with Proxy ARP enabled": AP will enable the optimization with Proxy ARP enabled in the meantime.</p>
<b>Convert IP multicast to unicast</b>	<p>When set to "Disabled": none of the multicast package will be converted;</p> <p>Passive mode: AP will never initiatively broadcast IGMP queries, and the IGMP snooping item will be aged out 300 seconds after it is registered, which may result in the failure of forwarding multicast data.</p>





	Active mode: AP will initiatively broadcast IGMP queries to keep updating of the IGMP snooping items.
<b>Enable Schedule</b>	Enable this option to assign a schedule for the bandwidth rule.
<b>Schedule</b>	Within the time of schedule, SSID can be used.
<b>Enable Voice Enterprise</b>	<p>Check to enable/disable Voice Enterprise.</p> <p>The roaming time will be reduced once enable voice enterprise.</p> <ul style="list-style-type: none"> <li>• The 802.11k standard helps clients to speed up the search for nearby APs that are available as roaming targets by creating an optimized list of channels. When the signal strength of the current AP weakens, your device will scan for target APs from this list.</li> <li>• When your client device roams from one AP to another on the same network, 802.11r uses a feature called Fast Basic Service Set Transition (FT) to authenticate more quickly. FT works with both pre-shared key (PSK) and 802.1X authentication methods.</li> <li>• 802.11v allows client devices to exchange information about the network topology, including information about the RF environment, making each client network aware, facilitating overall improvement of the wireless network.</li> </ul> <p><b>Note:</b> 11R is required for enterprise audio feature, 11V and 11K are optional. <i>This field is available only when “Security Mode” is set to “WPA/WPA2” or “WPA2”.</i></p>
<b>Enable 11R</b>	Check to enable 802.11r. <i>This field is available only when “Security Mode” is set to “WPA/WPA2” or “WPA2”.</i>
<b>Enable 11K</b>	Check to enable 802.11k
<b>Enable 11V</b>	Check to enable 802.11v
<b>ARP Proxy</b>	This option will enable GWN AP to answer the ARP requests from its LAN for its connected Wi-Fi clients. This is mainly to reduce the airtime consumed by ARP Packets



- **Device Membership:** Used to add or remove paired access points to the SSID.

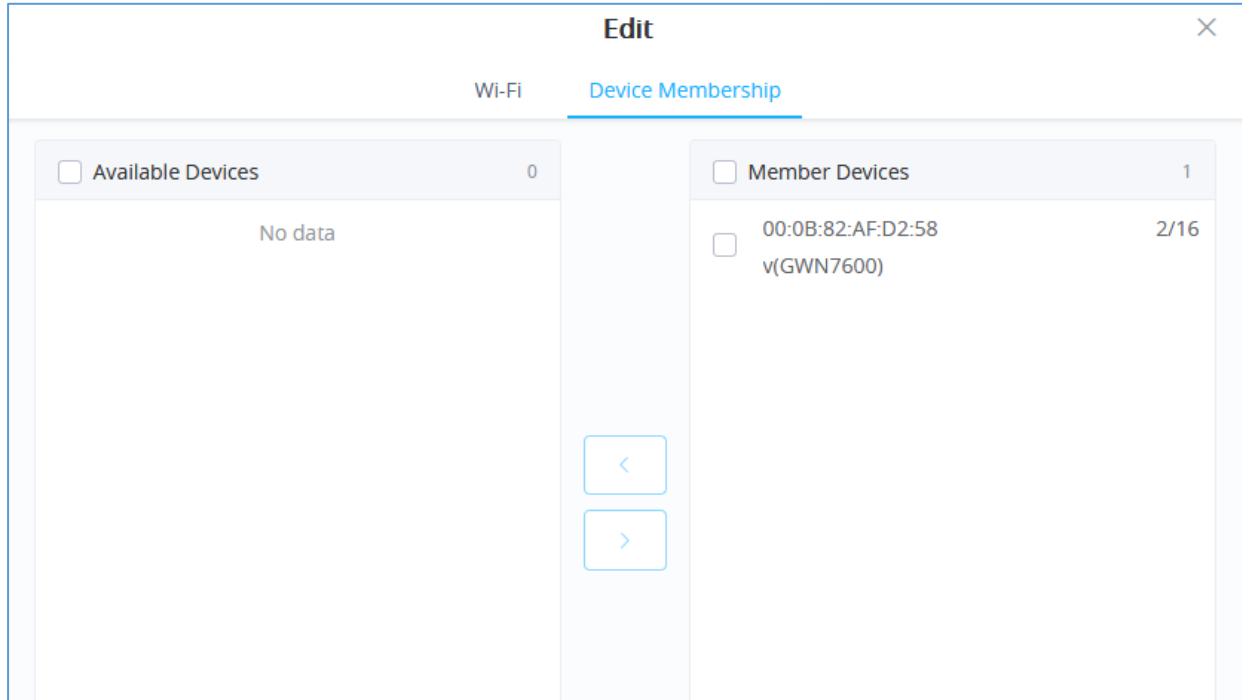




Figure 60: Device Membership




Click on  to add the GWN76XX to the SSID or click on  to remove it.

## CLIENTS

Users can configure clients' parameters, time policy and also check the list of the clients that has been banned after time disconnect policy has been enabled. Below we discuss each section of this menu:




### Clients


Users can access clients list connected to GWN76XX from **Web GUI → Clients → Clients** to perform different actions to wireless clients.

MAC	Hostname	Manufacture	OS	Type	IP Address	Radio/Chann	Status	RSSI	SSID	AP	Station Mode	Link Rate	Throughput	Aggregate	Actions
24:18:1D:A1:27:...	Galaxy-S9	SAMSUNG	Android	Wire...	192.168.5.171	5GHz	Online	34	GWNBS2398	00:08:82:B5:23:...	11AC_VHT...	TX:650Mbps RX:585Mbps	TX:140B/s RX:266B/s	TX:1.44MB RX:5.68MB	  

Showing 1-1 of 1 records. Per Page: 10

Figure 61: Clients

- Click on  under Actions to check client's status and modify basic settings such Device's Name.
- Click on  to block a client's MAC address from connecting to the zone's SSID.
- Click on  to release Wi-Fi offline client IP lease.

Users can press  button to customize items to display on the page. Following items are supported:

Select up to 16 items

- MAC
- Hostname
- Manufacture
- OS
- Type
- IP Address
- Radio/Channel
- Status
- RSSI
- Bridge
- SSID
- AP
- Station Mode
- Link Rate
- Throughput
- Aggregate



[Default](#)

**Figure 62: Clients - Select Items**

## ACCESS CONTROL

### Access List

From this menu, users can manage in global way the blacklist of clients that will be blocked from accessing the Wi-Fi network, click on **Client Access** to add or remove MAC addresses of client from global blacklist.

Name	MAC Addresses	Actions
Global Blacklist	(2) 48:4B:AA:08:3F:92, 48:4B:AA:08:3F:90	 

**Figure 63: Global Blacklist**

Edit

---

Name

MAC Addresses

-

-

Add new item +

**Figure 64: Managing the Global Blacklist**

A second option is to add custom access lists that will be used as matching mechanism for MAC address filtering option under SSIDs to allow (whitelist) or disallow (blacklist) clients access to the Wi-Fi network.

Click on **+ Add** in order to create new access list, then fill it with all MAC addresses to be matched.

Add

---

Name

MAC Addresses

-





Add new item +

Enable Schedule

Schedule

**Figure 65: Adding Client Access List**

Users can check « Enable Schedule » to assign a schedule for the list when it will take effect.

+ Add		
Name	MAC Addresses	Actions
Global Blacklist		 
Access List 1	(3) 48:4B:AA:08:3F:90, 48:4B:AA:08:3F:91, 48:4B:AA:08:3F:92	 

**Figure 66: Adding New Access List**

Once this is done, this access list can be used under SSID Wi-Fi settings to filter clients either using whitelist or blacklist mode.

Edit

Wi-Fi
Device Membership

---

Enable Captive Portal

Enable Schedule

Security Mode Open ▼

Client Bridge Support ?

Client Time Policy None ▼

Use MAC Filtering Blacklist ▼

MAC Blacklist ?  Access List 1

**Figure 67: Blacklist Access List**

## Time Policy

The timed client disconnect feature allows the system administrator to set a fixed time for which clients should be allowed to connect to the access point, after which the client will no longer be allowed to connect for a user configurable cool-down period.

The configuration is based on a policy where the administrator can set the amount of time for which clients are allowed to connect to the Wi-Fi and reconnect type and value after which they will be allowed to connect back after they have been disconnected.


To create a new policy, go under **Clients→Time Policy** and add new one. Then set the following parameters:




**Table 20: Time Policy Parameters**

Option	Description
<b>Name</b>	Enter the name of the policy
<b>Enabled</b>	Check the box to enable the policy
<b>Limit Client Connection Time</b>	Sets amount of time a client may be connected.
<b>Client Reconnect Timeout Type</b>	Select the method with which we will reset a client's connection timer so they may reconnect again. Options are: <ul style="list-style-type: none"> <li>• Reset Daily.</li> <li>• Reset Weekly.</li> <li>• Reset Hourly.</li> <li>• Timed Reset.</li> </ul>
<b>Client Reconnect Timeout</b>	If "Timed Reset" is selected, this is the period for which the client will have to wait before reconnecting.
<b>Day of the Week</b>	If "Reset Weekly" is selected, this is the day when the reset will be applied.
<b>Hour of the Day</b>	If "Reset Weekly" or "Reset Daily" is selected, this is the hour and day when the reset will be applied.

**Note:** Time tracking shall be accounted for on a per-policy basis, such that a client connected to any SSID assigned the time tracking policy will accrue a common counter, regardless of which SSID they are connected to (as long as those SSIDs all share the same time tracking policy).

## Banned Clients

Click on **Banned Clients** menu to view the list of the clients that have been banned after time disconnect feature has taken effect, these clients will not be allowed to connect back until timeout reset or you can unblock a client by clicking on the icon .


Banned Clients			
MAC Addresses	Time Policy	Release Time	Actions
A0:CB:FD:F4:DF:FE	5minute	2017-08-24 11:40:00	
30:75:12:FF:37:89	5minute	2017-08-24 11:40:00	
DC:09:4C:A4:38:BE	5minute	2017-08-24 11:41:00	

**Figure 68: Ban/Unban Client**

## Bandwidth Rules

The bandwidth rule is a GWN76XX feature that allows users to limit bandwidth utilization per SSID or client (MAC address or IP address).

This option can be configured from the GWN76XX WebGUI under “Bandwidth Rules”.

Click  to add a new rule, the following table provides an explanation about different options for bandwidth rules.

**Table 21: Bandwidth Rules**

Field	Description
<b>Enable</b>	Enable/Disable the Bandwidth rule.
<b>SSID</b>	Select which SSID will be affected by the bandwidth rule limitation.
<b>Range Constraint</b>	Choose the type of rule to be applied on bandwidth utilization from the dropdown list, three options are available: <ul style="list-style-type: none"> <li>• <b>Per-SSID:</b> Set a bandwidth limitation on the SSID level.</li> <li>• <b>Per-User:</b> Set a bandwidth limitation per Client.</li> <li>• <b>MAC:</b> Set a bandwidth limitation per MAC address.</li> <li>• <b>IP Address:</b> Set a bandwidth limitation per IP address.</li> </ul>
<b>MAC</b>	Enter the MAC address of the device to which the limitation will be applied, this option appears only when MAC type is selected.
<b>IP address</b>	Enter the IP address of the device to which the limitation will be applied, this option appears only when IP Address type is selected.
<b>Enable Schedule</b>	Enable this option to assign a schedule for the bandwidth rule.
<b>Upload Limit</b>	Specify the limit for the upload bandwidth using Kbps or Mbps.
<b>Download Limit</b>	Specify the limit for the download bandwidth using Kbps or Mbps.

The following figure shows an example of MAC address rule limitation.





Add

Enable

SSID

All
None

---

GWN9A9658

Range Constraint

MAC ▼

MAC

00:0b:82:15:af:19

Enable Schedule (?)

Upload Limit

2

Mbps ▼

Download Limit

2

Mbps ▼

**Figure 69: MAC Address Bandwidth Rule**

The following figure shows examples of bandwidth rules:

Enabled	SSID	Range Constraint	MAC/IP Address	Upload Limit	Download Limit	Actions
✓	GWNAAD4D8	Per-SSID		100Mbps	150Mbps	<span style="color: #007bff; font-size: 1.2em;">✎</span> <span style="color: #dc3545; font-size: 1.2em;">🗑</span>

**Figure 70: Bandwidth Rules**

**Note:**

The same settings for bandwidth management are available from the following menus:

**Per-Client**

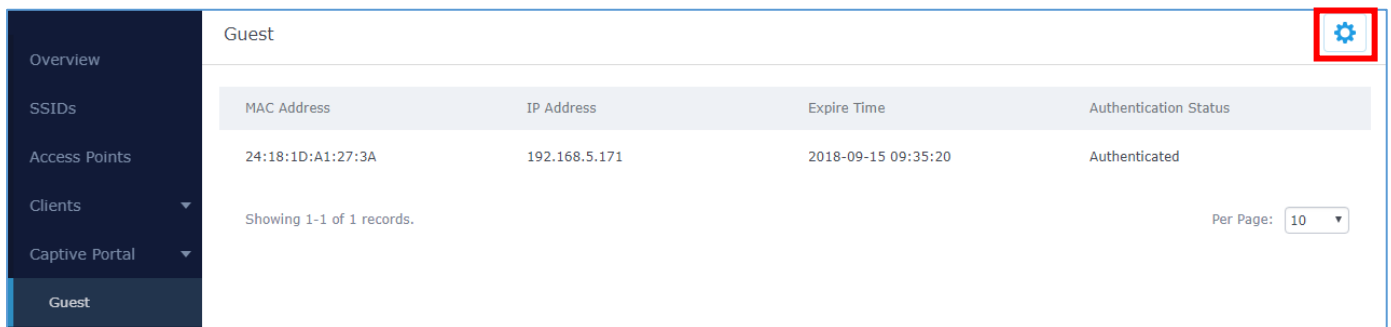
Navigate on the web GUI under “Clients→Edit→Bandwidth Rules” where you can set the Upstream and Downstream rate in Mbps.

## CAPTIVE PORTAL

Captive Portal feature on GWN76XX AP helps to define a Landing Page (Web page) that will be displayed on Wi-Fi clients' browsers when attempting to access Internet. Once connected to a GWN76XX AP, Wi-Fi clients will be forced to view and interact with that landing page before Internet access is granted. The Captive Portal feature can be configured from the GWN76XX Web page under "Captive Portal". The page contains following sub-menus: **Guest**, **Policy List**, **Splash Page** and **Vouchers**.

### Guest


This section lists the clients connected or trying to connect to Wi-Fi via Captive Portal.



MAC Address	IP Address	Expire Time	Authentication Status
24:18:1D:A1:27:3A	192.168.5.171	2018-09-15 09:35:20	Authenticated

Showing 1-1 of 1 records. Per Page: 10

**Figure 71: Captive Portal – Guest Page**

Users can press  button to customize items to display on the page. Following items are supported:

Select up to 8 items

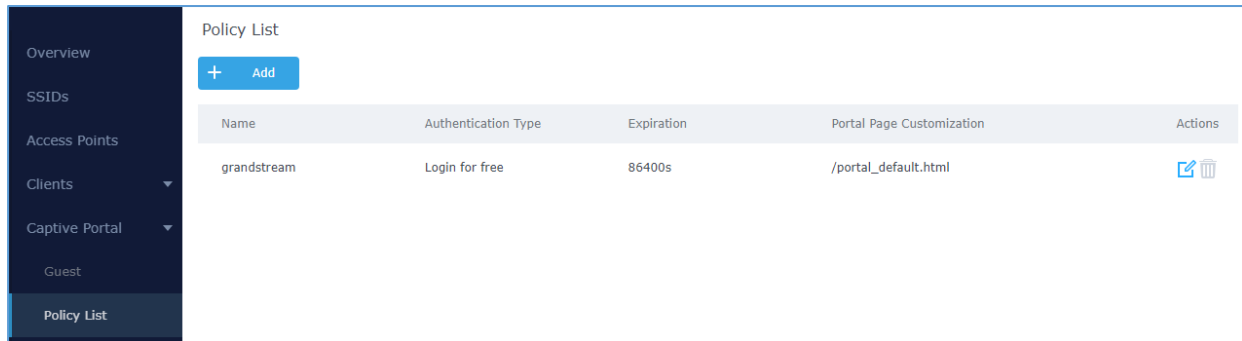
- Name
- MAC Address
- IP Address
- Email
- Gender
- Age Range
- Expire Time
- Authentication Status



[Default](#)

**Figure 72: Captive Portal - Guest Page - Select Items**




## Policy List

Users can customize a portal policy in this page.



Name	Authentication Type	Expiration	Portal Page Customization	Actions
grandstream	Login for free	86400s	/portal_default.html	 

**Figure 73: Captive Portal - Policy List**

- Click on  to edit the policy.
- Click on  to delete the policy.
- Click on  to add a policy.

The policy configuration page allows adding multiple captive portal policies which will be applied to SSIDs and contains options for different authentication types a splash page that can be easily configured as shown on the next section.

Administrator can use an internal or external splash page.

**Edit**

Basic
Auth Rule

Name

Splash Page

Authentication Type

Client Expiration

Client Idle Timeout

Use Default Portal Page

Portal Page Customization

Landing Page

Enable Daily Limit

Enable HTTPS Redirection

Enable Secure Portal

Figure 74: Add a New Policy

### Internal Splash Page

Below table lists the items policy add page configures

Table 22: Captive Portal – Policy List – Splash Page is “Internal”

Field	Description
Name	Enter the name of the Captive Portal policy
Splash Page	Select Splash Page type, Internal or External.
Authentication Type	Following types of authentication are available:

	<ul style="list-style-type: none"> <li>• <b>Login for free:</b> when choosing this option, the landing page feature will not provide any type of authentication, instead it will prompt users to accept the license agreement to gain access to internet.</li> <li>• <b>RADIUS Server:</b> Choosing this option will allow users to set a RADIUS server to authenticate connecting clients.</li> <li>• <b>Social Login Authentication:</b> Choosing this option will allow users to enable authentication Facebook or Twitter.</li> <li>• <b>Vouchers:</b> Choose this page when using authentication via Vouchers.</li> <li>• <b>Login with Password:</b> Choose this page when using authentication via a password.</li> </ul>
<b>Client Expiration</b>	Configures the period of validity, after the valid period, the client will be re-authenticated again.
<b>Client Idle Timeout</b>	Configure the time when the client will automatically deauthenticate when it is idle. <i>This does not apply to Voucher Captive portal mode.</i>
<b>If Authentication Type is set to RADIUS Authentication</b>	
<b>RADIUS Server Address</b>	Fill in the IP address of the RADIUS server.
<b>RADIUS Server Port</b>	Set the RADIUS server port. The default value is 1812.
<b>RADIUS Server Secret</b>	Fill in the key of the RADIUS server.
<b>RADIUS Authentication Method</b>	Select the RADIUS authentication method, 3 methods are available: PAP, CHAP and MS-CHAP.
<b>If Authentication Type is set to "Social Login Authentication"</b>	
<b>Facebook</b>	Check to enable/disable Facebook Authentication
<b>Facebook App ID</b>	Fill in the Facebook App ID.
<b>Facebook APP Secert</b>	Set the key for the portal, once clients want to connect to the Wi-Fi, they should enter this key.
<b>Twitter</b>	Check this box to enable Twitter Authentication.
<b>Force to Follow</b>	If checked, users need to Follow owner before been authenticated.
<b>Owner</b>	Enter the app Owner to use Twitter Login API. <i>This field appears only when <b>Force to Follow</b> is checked.</i>
<b>Consumer Key</b>	Enter the app Key to use Twitter Login API.
<b>Consumer Secret</b>	Enter the app secret to use Twitter Login API.
<b>For all Authentication Types</b>	



<b>Use Default Portal Page</b>	<p>If checked, the users will be redirected to the default portal page once connected to the GWN.</p> <p>If unchecked, users can manually select which Portal Page to use from <b>Portal Page Customization</b> drop-down list.</p>
<b>Portal Page Customization</b>	<p>Select the customized portal page (if “Use Default Portal Page” is unchecked).</p> <ul style="list-style-type: none"> <li>• /facebook.html</li> <li>• /password_auth.html</li> <li>• /portal_default.html</li> <li>• /portal_pass.html</li> <li>• /portal_tip.html</li> <li>• /social_auth.html</li> <li>• /status.html</li> <li>• /twitter.html</li> <li>• /twitter_website.html</li> <li>• /vouchers_auth.html</li> </ul>
<b>Landing Page</b>	<p>Choose the landing page, 2 options are available:</p> <ul style="list-style-type: none"> <li>• <b>Redirect to the Original URL.</b></li> <li>• <b>Redirect to External Page.</b></li> </ul>
<b>Redirect External Page URL Address</b>	<p>Once the landing page is set to redirect to external page, user should set the URL address for redirecting.</p> <p><i>This field appears only when <b>Landing Page</b> is set to “Redirect to an External Page”.</i></p>
<b>Enable Daily Limit</b>	<p>If enabled, captive portal will limit user connection by times of one day.</p>
<b>Failsafe Mode</b>	<p>If checked, AP will grant access to STA if AP can't reach to external authentication server.</p> <p><i>This option is available only when <b>Authentication Type</b> is set to “RADIUS Server” or “Vouchers”.</i></p>
<b>Enable HTTPS Redirection</b>	<p>Check to enable/disable HTTPS service. If enabled, both HTTP and HTTPS requests sent from stations will be redirected by using HTTPS protocol. And station may receive an invalid certification error while doing HTTPS browsing before authentication. If disabled, only the http request will be redirected.</p> <p><i>This is Not supported in GWN7610/GWN7602.</i></p>
<b>Enable Secure Portal</b>	<p>Enable Secure Portal: If enabled, unauthorized guests will be redirected to the splash page by using HTTPS protocol. If not, the HTTP protocol will be used.</p>

**Notes:**

1. If Facebook authentication is configured, you will need to log in your Facebook account of <https://developers.facebook.com/apps> , and set the OAuth redirect to : <https://cwp.gwn.cloud:8443/GsUserAuth.cgi?GsUserAuthMethod=3>
2. If Twitter authentication is configured, you will need to log in your Twitter account of <https://apps.twitter.com/app>, and set the callback URLs to: <http://cwp.gwn.cloud:8080/GsUserAuth.cgi>

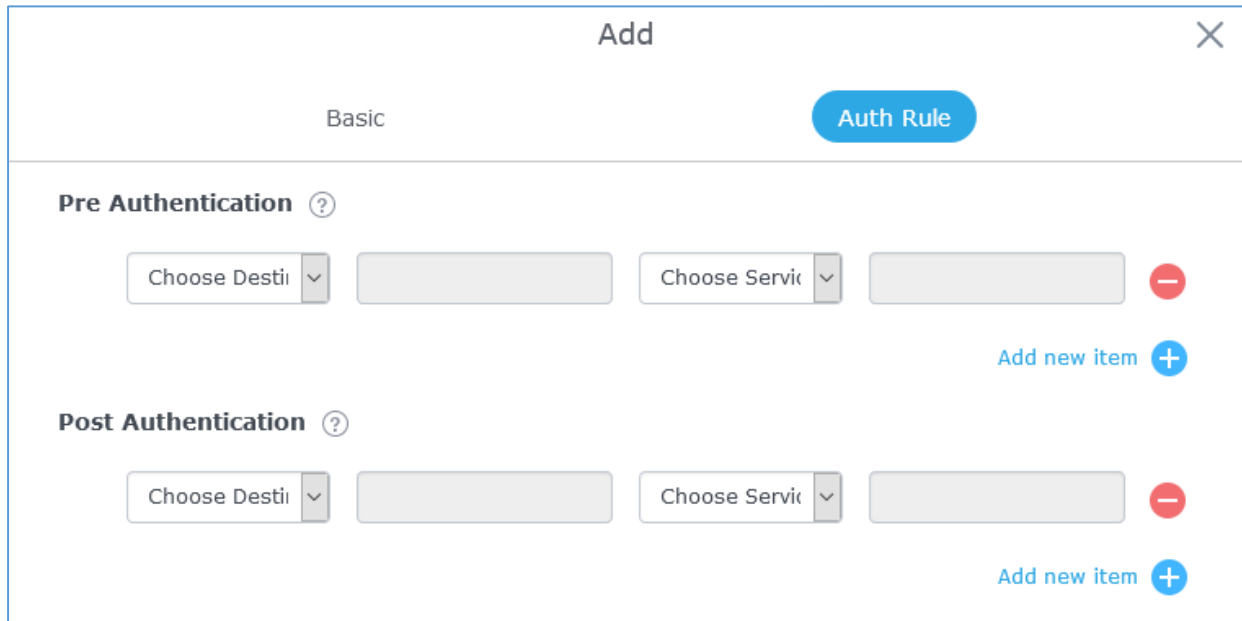
## External Splash Page

**Table 23: Captive Portal – Policy List – Splash Page is “External”**

Field	Description
<b>Name</b>	Enter the name of the Captive Portal policy
<b>Splash Page</b>	Select to either use <b>Internal</b> or <b>External</b> Splash Page.
<b>External Splash Page URL</b>	Enter the External Splash Page URL, and make sure to enter the pre-authentication rules request by the external portal platform in the pre-authentication configuration option.
<b>RADIUS Server Address</b>	Fill in the IP address of the RADIUS server.
<b>RADIUS Server Port</b>	Set the RADIUS server port, the default value is 1812.
<b>RADIUS Server Secret</b>	Fill in the key of the RADIUS server.
<b>RADIUS Accounting Server</b>	Configures the address for the RADIUS accounting server address.
<b>RADIUS Accounting Server Port</b>	Configures RADIUS accounting server listening port (default is 1813).
<b>RADIUS Accounting Server Secret</b>	Enter the secret password for client authentication with RADIUS accounting server.
<b>Accounting Update Interval</b>	Enter Update Interval for RADIUS Accounting Server. The interval unit can be set by seconds, minutes, hours or days.
<b>RADIUS NAS ID</b>	Enter RADIUS NAS ID. <i>This field appears only when <b>Splash Page</b> is set to “External”.</i>
<b>Redirect URL</b>	Specify URL where to redirect clients after authentication.

In case social media authentication is used, the user needs to allow some traffic between the AP and social medial platforms (Facebook API as example) to send authentication credentials and receive reply, this traffic can be allowed using the Authentication rules which are explained below.





**Figure 75: Authentication rules**

## Pre-Authentication Rules

Using this option, users can set rules to match traffic that will be allowed for connected Wi-Fi users before authentication process. This can be needed for example to setup Facebook authentication where some traffic should be allowed to Facebook server(s) to process the user's authentication. Or simply to be used to allow some type of traffic for unauthenticated users.

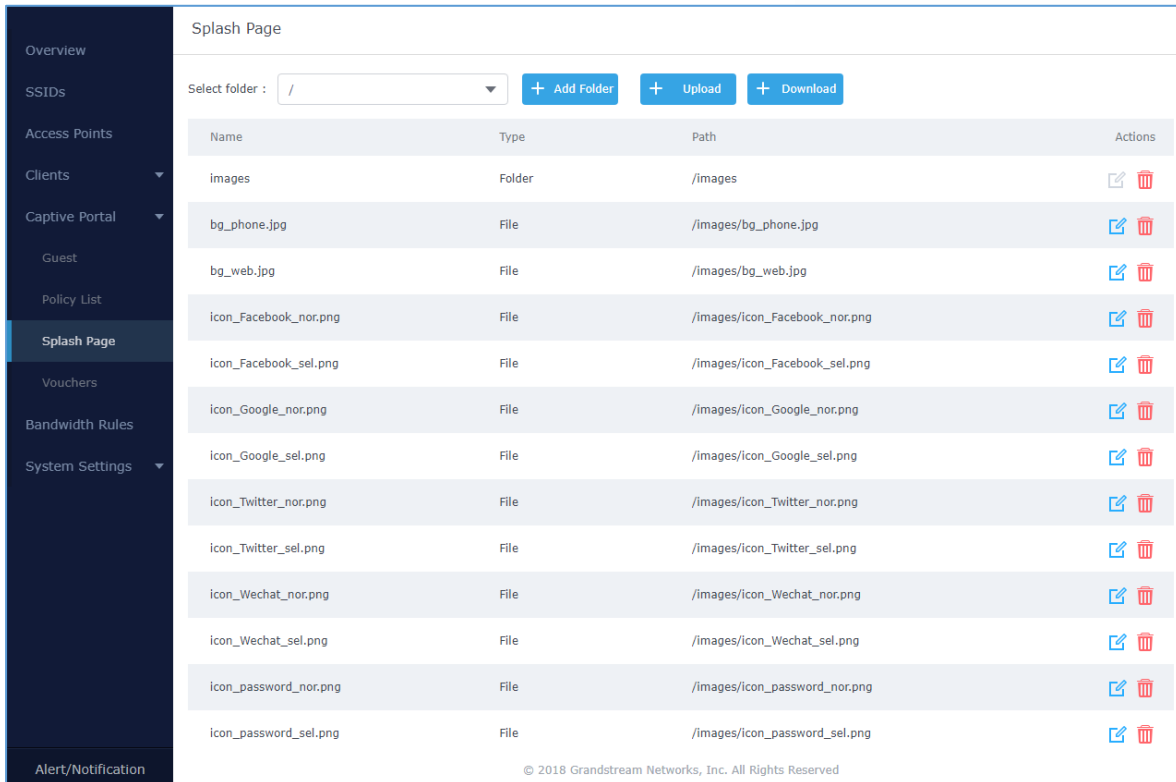
## Post-Authentication Rules

On the other hand, post authentication rules are used to match traffic that will be banned for Wi-Fi clients after authentication. As an example, if you want to disallow connected Wi-Fi clients to issue Telnet or SSH traffic after authentication then you can set post authentication rules to match that traffic and once a connected client passes the authentication process they will be banned from issuing telnet and SSH connections.


## Splash Page





Files configuration page allows users to view and upload HTML pages and related files (images...).





**Figure 76: Captive Portal – Splash Page**

User can add folder in corresponding folder by selecting the folder and click on .

- Click on  to upload a file from local device.
- Click on  to download the files in Captive Portal folder.
- Click on  to edit the corresponding file, in another word, to replace the file with a new one.
- Click on  to delete the file.

## Vouchers

### Voucher Feature Description

Voucher feature will allow clients to have internet access for a limited duration using a code that is randomly generated from GWN controller.

As an example, a coffee shop could offer internet access to customers via Wi-Fi using voucher codes that can be delivered on each command. Once the voucher expires the client can no longer connect to the internet.

Note that multiple users can use a single voucher for connection with expiration duration of the voucher that starts counting after first successful connection from one of the users that are allowed.


Another interesting feature is that the admin can set data bandwidth limitation on each created voucher depending on the current load on the network, users' profile (VIP customers get more speed than regular ones...etc.) and the internet connection available (fiber, DSL or cable...etc.) to avoid connection congestion and slowness of the service.

Each created voucher can be printed and served to the customers for usage, and the limit is 1000 vouchers.




The usage of voucher feature needs to be combined with captive portal that is explained after this section, in order to have the portal page requesting clients to enter voucher code for authentication.

## Voucher Configuration

To configure/create vouchers for clients to use, follow below steps:

1. On controller web GUI, navigate under “**Captive Portal → Vouchers**”
2. Click on  button in order to add a new voucher.
3. Enter voucher details which are explained on the next table.
4. Press save to create the voucher(s).

### Notes:

- Users can specify how many vouchers to generate which have the same profile, this way the GWN will generate as many vouchers as needed which do have the same settings avoiding creating them one by one.
- The admin can verify the status of each vocoder on the list (In use, not used, expired ...etc.).
- Press  to print the voucher,  to delete it or  to renew the voucher.

**CREATE VOUCHERS** ✕

Create Quantity ? 

The field cannot be empty.

Max Devices ? 

The field cannot be empty.

Byte Limit ?  MB ▾

Duration  Minute(s) ▾

The field cannot be empty.

Validity Time ? 

The field cannot be empty.

Download Limit ?  Mbps ▾

Upload Limit ?  Mbps ▾

Notes

Save
Cancel

**Figure 77: Add Voucher Sample**

The below figure shows the status of the vouchers after GWN randomly generates the code for each one.

Code	Validity Time	Download Limit	Upload Limit	Byte Quota	Remaining Byte	Duration	Status	Max Devices	Notes	Actions
<input type="checkbox"/> 0122828541	2022-04-25 06:15:22	-	-	800.00MB	800.00MB	2h	Not used	0/5		<span style="color: blue;">🖨️</span> <span style="color: red;">🗑️</span> <span style="color: gray;">🔍</span>

**Figure 78: Vouchers List**

Users can click on buttons 🗑️ Delete and 🖨️ Print to delete and print multiple vouchers or click 🖨️ Print All button to print all vouchers at once.

Also, users can use the drop-down list filter All Created Time ▾ to filter the vouchers that were created at specific date-time.

The following table summarizes description for voucher configuration parameters:


**Table 24: Voucher Parameters**

Field	Description
-------	-------------

<b>Create Quantity</b>	Specify how many vouchers to generate which will have same profile/settings (duration, bandwidth and number of users). Valid range: 1 – 1000.
<b>Max Devices</b>	Specify how many users can use same voucher. Valid range: 1 – 5.
<b>Byte Limit</b>	Specify download byte limit for the voucher. The unit can be either <b>M</b> (Megabyte) or <b>G</b> (Gigabyte). Valid range: 10 – 1048576 (M) 1 – 1024 (G)
<b>Duration</b>	Specify the duration after which the voucher will expire, and clients will be disconnected from internet. <b>Note:</b> in case or multiple users, the duration will start counting after first user starts using the voucher.
<b>Validity Time</b>	Set the validity period of credentials, limited to 1-365 integer. The unit is day.
<b>Download Limit</b>	Set the downstream bandwidth speed limit (in Kbps or Mbps).
<b>Upload Limit</b>	Set the upstream bandwidth speed limit (in Kbps or Mbps).
<b>Notes</b>	Notes for the admin when checking the list of vouchers.

### Using Voucher with GWN Captive Portal

In order to successfully use the voucher feature, users will need to create a captive portal in order to request voucher authentication codes from users before allowing them access to internet. More details about captive portal will be covered on next section but for voucher configuration please follow below steps.

1. Go under “**Captive Portal → Captive portal**” menu.
2. Press  in order to add new captive portal policy.
3. Set the following parameters as shown on the screenshot for basic setup then save and apply.

Add✕

Name	<input type="text" value="VoucherPortal"/>
Authentication Type	<input type="text" value="Vouchers"/>
Use Default Portal Page	<input checked="" type="checkbox"/>
Portal Page Customization	<input type="text" value="/vouchers_auth.html"/>

**Figure 79: Captive Portal with Voucher authentication**

Then go under your SSID configuration page and enable the generated captive portal under Wi-Fi settings tab.

## RADIO

When using GWN76XX as Master Access Point, users can edit the frequency band used by the AP and channel used along with the Transmission power for each band.

Log in as Master to the GWN76XX Web GUI and go to **Radio**.

**General**

Band Steering ?

Client Steering ?

Airtime Fairness

Beacon Interval ?

Wi-Fi5 Compatible Mode ?

Country/Region

---

**2.4G (802.11b/g/n/ax) ?**

Channel Width ?

40MHz Channel Location ?

Channel ?

Radio Power ?

Enable Short Guard Interval ?

Allow Legacy Devices(802.11b)

Enable Minimum RSSI ?

Minimum Access Rate Limit ?

---

**5G (802.11a/n/ac/ax) ?**

Channel Width ?

Channel ?

Radio Power ?

Enable Short Guard Interval ?

Enable Minimum RSSI ?

Minimum Access Rate Limit ?

**Figure 80: Radio-General**

**Table 25: Radio Settings**

General	
Field	Description
<b>Band Steering</b>	When Frequency is set to Dual-Band, users can check this option to enable Band Steering on the Access Point, this will help redirecting clients to a radio band accordingly for efficient use and to benefit from the maximum throughput supported by the client.
<b>Client Steering</b>	This feature will help Wi-Fi client to roam to other APs within same Network. Parameters of RSSI Threshold and Client Access Threshold parameters will show up only when Client Steering is enabled.
<b>Airtime Fairness</b>	Allow faster clients to have more airtime than slower clients. <i>This feature is not supported on GWN7600/GWN7600LR/GWN7610.</i>
<b>Beacon Interval</b>	<p>Configures interval between beacon transmissions/broadcasts. The Beacon signals help to keep the network synchronized and provide main information about the network such as SSID, Timestamp...</p> <ul style="list-style-type: none"> <li>• <b><u>Using High Beacon Interval:</u></b> AP will be sending beacon broadcast less frequently. This will help to get better throughput, thus better speed/performance. It also helps to save Wi-Fi clients energy consumption.</li> <li>• <b><u>Using Low Beacon Interval:</u></b> AP will be sending beacon broadcast more frequently. This can help in environments with weak signal areas; sending more frequently beacons will increase chances to be received by Wi-Fi clients with weak signal.</li> </ul> <p><b>Notes:</b></p> <ol style="list-style-type: none"> <li>1. When AP enables several SSIDs with different interval values, the max value will take effect.</li> <li>2. When AP enables less than 3 SSIDs, the interval value which will be effective are the values from 40 to 500.</li> <li>3. When AP enables more than 2 but less than 9 SSIDs, the interval value which will be effective are the values from 100 to 500.</li> <li>4. When AP enables more than 8 SSIDs, the interval value which will be effective are the values from 200 to 500.</li> <li>5. Mesh feature will take up a share when it is enabled.</li> </ol>



<b>Wi-Fi5 Compatible Mode</b>	<p>Some old devices do not support Wi-Fi6 well, and may not be able to scan the signal or connect poorly. After turning on this switch, it will switch to Wi-Fi5 mode to solve the compatibility problem. At the same time, it will turn off Wi-Fi6 related functions.</p> <p><b>Note:</b> This only takes effect for GWN7660.</p>
<b>2.4G &amp; 5G Configuration</b>	<ul style="list-style-type: none"> <li>• <b>Channel Width:</b> Choose the Channel Width, note that wide channel will give better speed/throughput, and narrow channel will have less interference. 20Mhz is suggested in very high-density environment.</li> <li>• <b>40MHz Channel Location:</b> Configure the 40MHz channel location when using 20MHz/40MHz in Channel Width, users can set it to be Secondary below Primary, Primary below Secondary or Auto.</li> <li>• <b>Channel:</b> Select Auto, or a specified channel, default is Auto. Note that the proposed channels depend on <b>Country</b> Settings under <b>System Settings</b>→<b>Maintenance</b>.</li> <li>• <b>Radio Power:</b> Set the Radio Power, it can be Low, Medium or High, or Dynamically assigned by RRM (AP will actively change TX power depending on RRM settings).</li> <li>• <b>Enable Short Guard Interval:</b> Check to activate this option to increase throughput.</li> <li>• <b>Custom Wireless Power(dBm):</b> allows users to set a custom wireless power for both 5GHz/2.4GHz band, the value of this field must be between 1 and 31.</li> <li>• <b>Allow Legacy Devices(802.11b):</b> Check to support 802.11b devices to connect the AP in 802.11n/g mode. (2.4GHz setting)</li> <li>• <b>Dynamic Channel Assignment:</b> Once enabled, AP will try to allocate and move the best channel during operation, unlike Auto Channel Selection (ACS) which scan and assign channel when Wi-Fi interface goes up for one time.  <i>This feature is not supported on GWN7602/7660.</i></li> <li>• <b>Transmit Power Control:</b> TPC algorithm runs every 10 minutes. AP acquires the RSSI information of the neighbor by wireless scanning and establishes the neighbor table. The algorithm requires that there must be at least 3 neighbor APs with RSSI larger than -70dbm. Otherwise, power will not be adjusted.  <i>This feature is not supported on GWN7602/7660.</i></li> </ul>





- **Coverage Hole Detection:** CHD enables AP to decide whether to increase the AP power by the current SNR and SNR threshold of the connected clients.

*This feature is not supported on GWN7602/7660.*

- **Enable Minimum RSSI:** Check to enable RSSI function, this will lead the AP to disconnect users below the configured threshold in Minimum RSSI (dBm).
- **Minimum RSSI:** Enter the minimum RSSI value in dBm. If the signal value is lower than the configured minimum value, the client will be disconnected. The input range is from “-94” or “-1”.
- **Minimum Access Rate Limit:** Specify whether to limit the minimum access rate for clients. When enabled, it will help to eliminate the legacy connection which slow the total performance of the Wi-Fi network. Range from 1 to 54 Mbps.

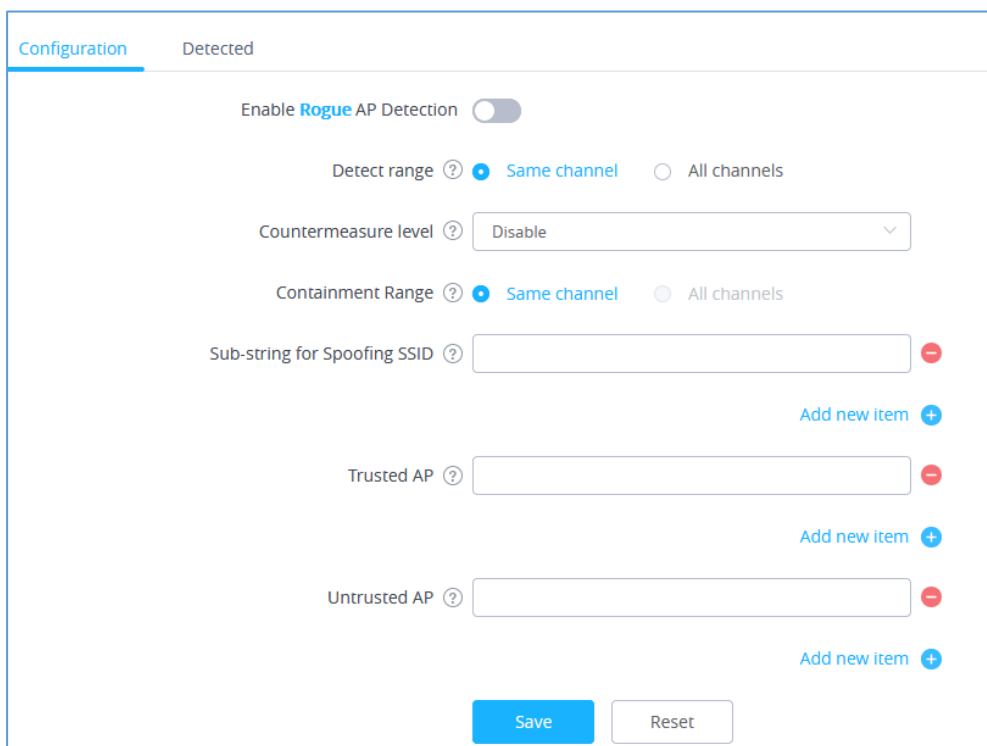


## SECURITY

### Rogue AP

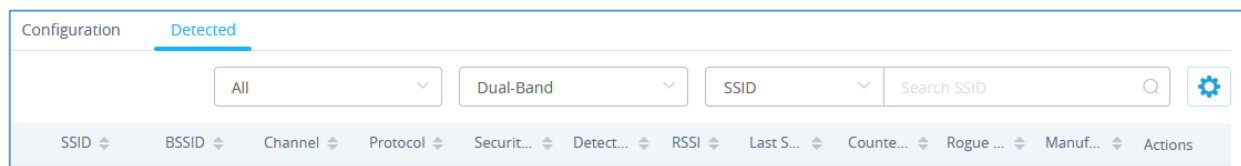
The GWN Access Points offer the ability to prevent malicious intrusion to the network and increases the wireless security access of clients when introducing Rogue AP detection. The detected APs will be listed with all the details under Detected section for further intervention. This feature is not supported in GWN7610/GWN7602.

In the figure below is the configuration page in order to enable the Rogue AP detection and we can set the trusted Aps on the network.



**Figure 81: Rogue AP-Configuration**

In the figure below we would have a list showing all the detected rogue AP on the network scanned by the GWN access point.



**Figure 82: Rogue AP-Detection**

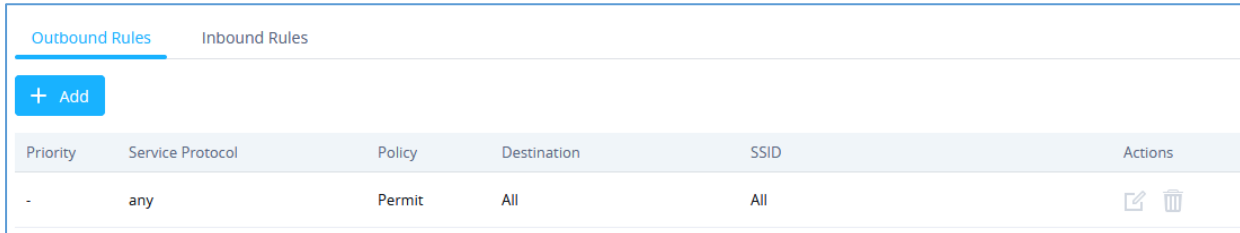
Table 26: Rogue AP

Field	Description
<b>Enable Rogue AP Detection</b>	Select to either to enable or disable Rogue AP scan.
<b>Detect range</b>	<p>Specify the rogue AP detect range.</p> <ul style="list-style-type: none"> <li>• <b>Same channel:</b> AP will execute simple detection on the APs around, this mode almost has no effects on the wireless network communication.</li> <li>• <b>All channels:</b> AP will execute a deep detection every 5 minutes. And the clients connecting to the AP will have few seconds of communication interrupt.</li> </ul> <p>Default is Same Channel.</p>
<b>Countermeasure level</b>	<p>Countermeasures level specifies the type of attacks which will be suspected by the AP. Select different levels:</p> <p><b>High:</b> Untrusted BSSID, Illegal access without authentication, Illegal access, Spoofing SSID.</p> <p><b>Medium:</b> Untrusted BSSID, Illegal access without authentication, Illegal access.</p> <p><b>Low:</b> Untrusted BSSID, Illegal access without authentication.</p> <p>Default is Disabled.</p>
<b>Containment Range</b>	<p>Specify the containment range:</p> <p><b>Same channel:</b> detect AP will countermeasure the APs in the same channel.</p> <p><b>All channels:</b> detect AP will countermeasure the APs in all channels at the cost of consuming of much AP performance.</p> <p>Default is Same Channel.</p>
<b>Sub-string for Spoofing SSID</b>	The AP broadcasting SSID with the specified string will be classified as a Spoofing SSID.
<b>Trusted AP</b>	You can specify MAC address of the trusted AP, which should be formatted as XX:XX:XX:XX:XX:XX. If an AP is defined as trusted AP, no countermeasures will be executed on it.
<b>Untrusted AP</b>	You can specify MAC address of the untrusted AP, which should be formatted as XX:XX:XX:XX:XX:XX. If an AP is defined as untrusted AP, countermeasures will be executed on it when countermeasure is enabled.



## Firewall

This section allows user to control the outgoing and incoming traffic from clients by manually setting up policies to either deny or permit the traffic based on protocol type and by specifying SSIDs and destinations.



The screenshot shows the 'Outbound Rules' configuration page. At the top, there are two tabs: 'Outbound Rules' (active) and 'Inbound Rules'. Below the tabs is a '+ Add' button. A table lists the rules with columns: Priority, Service Protocol, Policy, Destination, SSID, and Actions. One rule is visible with Priority '-', Service Protocol 'any', Policy 'Permit', Destination 'All', and SSID 'All'. The Actions column contains edit and delete icons.

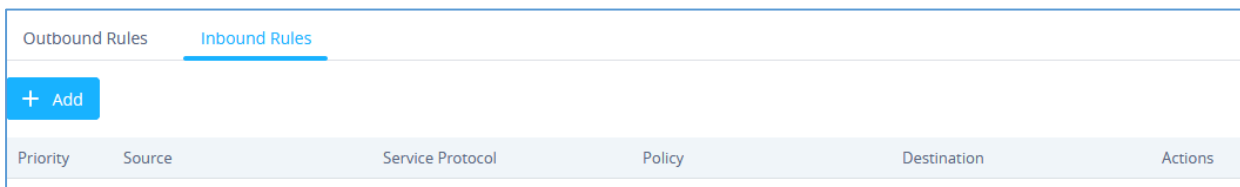
Priority	Service Protocol	Policy	Destination	SSID	Actions
-	any	Permit	All	All	

**Figure 83: Firewall-Outbound**

**Table 27: Firewall- Outbound**

Field	Description
<b>Service Protocol</b>	Select type of traffic to be affected by the outbound rule like ICMP, HTTP, HTTPS... or you may add another type of traffic when selecting Custom. When set to Custom, user could enter the following: <b>Protocol:</b> TCP or UDP <b>Port:</b> define the port used by this protocol.
<b>Policy</b>	Either select to Permit or Deny Outbound traffic.
<b>Destination</b>	Select either: <ul style="list-style-type: none"> <li>• <b>Particular Domain:</b> enter FQDN of a destination or string: for instance, entering test will block service to any domain name containing string test.</li> <li>• <b>Particular IP:</b> IP address of destination.</li> <li>• <b>Particular Network:</b> Network IP address.</li> <li>• <b>All:</b> the rule will apply on all destinations.</li> </ul>
<b>SSID</b>	Select one or multiple SSIDs to apply the rule on.

User can define outbound and inbound rules on the traffic from the options in figure below:



The screenshot shows the 'Inbound Rules' configuration page. At the top, there are two tabs: 'Outbound Rules' and 'Inbound Rules' (active). Below the tabs is a '+ Add' button. A table lists the rules with columns: Priority, Source, Service Protocol, Policy, Destination, and Actions.

Priority	Source	Service Protocol	Policy	Destination	Actions
----------	--------	------------------	--------	-------------	---------

**Figure 84: Firewall-inbound**

**Table 28: Firewall-Inbound**

Field	Description
<b>Service Protocol</b>	Select type of traffic to be affected by the inbound rule like ICMP, HTTP, HTTPS... or you may add another type of traffic when selecting Custom. When set to Custom, user could enter the following: <b>Protocol:</b> TCP or UDP <b>Port:</b> define the port used by this protocol.
<b>Policy</b>	Either select to Permit or Deny inbound traffic.
<b>Source</b>	Select either: <ul style="list-style-type: none"> <li>• <b>Particular IP:</b> IP address of source.</li> <li>• <b>Particular Network:</b> Network IP address.</li> <li>• <b>All:</b> the rule will apply on all destinations.</li> </ul>
<b>Destination</b>	Configure the destination address. <ul style="list-style-type: none"> <li>• <b>All</b></li> <li>• <b>Particular IP</b></li> <li>• <b>Particular Domain</b></li> <li>• <b>Particular Network</b></li> </ul>

## SERVICE

### Hotspot 2.0

This section lists the configuration page to Hotspot 2.0. This is a technology that allows mobile devices to automatically connect to available Passpoint-certified WiFi hotspots. This gives the device liberty to hop from one hotspot on a network to another without the need log in to each hotspot. This feature is currently a beta. *This is not supported in GWN7610/GWN7602/GWN7660.*

To enable this feature, proceed from Access Point's web page → Service → Hotspot 2.0:

**General Settings**

Name

Domain ID

HESSID

Network Access  Internet Access

Network Type

IPv4 Type

IPv6 Type

Network Auth Type

---

**Venue**

---

**Operator Name**

Figure 85: Hotspot 2.0

Table 29: Hotspot 2.0

General	
Field	Description
Name	Set name of the hotspot.
Domain ID	Set the Domain ID.
HESSID	Configure the Homogenous Extended Service Set Identifier information for Hotspot2.0.

	This value must be consistent with the BSSID of an AP to identify the AP set that provides the same network access service. The format is H:H:H:H:H:H, where H is a 2-digit hexadecimal number.
<b>Network Access</b>	Enabled or disable internet access.
<b>Network Type</b>	<p>Select network type:</p> <ul style="list-style-type: none"> <li>• Private network</li> <li>• Private network with guest access</li> <li>• Chargeable public network</li> <li>• Free public network</li> <li>• Personal device network</li> <li>• Emergency services only network</li> <li>• Test or experimental</li> <li>• Wildcard</li> </ul>
<b>IPv4 Type</b>	<p>Select IPv4 Type:</p> <ul style="list-style-type: none"> <li>• Address type not available</li> <li>• Public IPv4 address available</li> <li>• Port-restricted IPv4 address available</li> <li>• Single NATed private IPv4 address available</li> <li>• Double NATed private IPv4 address available</li> <li>• Port-restricted IPv4 address and single NATed IPv4 address available</li> <li>• Port-restricted IPv4 address and double NATed IPv4 address available</li> <li>• Availability of the address type not known</li> </ul>
<b>IPv6 Type</b>	<p>Select IPv4 Type:</p> <ul style="list-style-type: none"> <li>• Address type not available</li> <li>• Address type available</li> <li>• Availability of the address type not known</li> </ul>
<b>Network Auth Type</b>	<p>Configure the Network authentication type to help users find and select the right network. Select either:</p> <ul style="list-style-type: none"> <li>• Acceptance of terms and conditions</li> <li>• On-line enrollment supported</li> <li>• http/https redirection</li> <li>• DNS redirection</li> <li>• Not configured</li> </ul>
<b>Venue</b>	
<b>Venue Group</b>	<p>Select the Venue Group type:</p> <ul style="list-style-type: none"> <li>• Unspecified</li> <li>• Assembly</li> <li>• Business</li> <li>• Educational</li> </ul>



	<ul style="list-style-type: none"> <li>• Factory</li> <li>• Institutional</li> <li>• Mercantile</li> <li>• Residential</li> <li>• Storage</li> <li>• Utility</li> <li>• Vehicular</li> <li>• Outdoor</li> </ul>
<b>Venue Type</b>	Select the Venue type, which will depend on the Venue Group.
<b>Language Code</b>	Select the language.
<b>Venue Name</b>	Set the Venue name.
<b>Operator Name</b>	
<b>Language Code</b>	Select the language.
<b>Operator Name</b>	Set the Operator name.
<b>Roaming Consortium</b>	
<b>Roaming Consortium Name</b>	Configure the Roaming Consortium Name to identify network operators. The format is H-H-H or H-H-H-H-H, where H is a 2-digit hexadecimal number.
<b>Domain</b>	
<b>Domain</b>	Enter the domain name.
<b>Realm</b>	
<b>Realm</b>	Select the EAP Method: EAP-TLS, EAP-SIM, EAP-TTLS, EAP-AKA and EAP-AKA'.
<b>Cellular Network Information</b>	
<b>Cellular Network Information</b>	Enter the Name, Country Code and Network Code.
<b>Port Configuration</b>	
<b>IP Protocol</b>	Configure the protocol type: ICMP, TCP, UDP or ESP.
<b>Port Number</b>	Set the protocol port.
<b>Port Status</b>	Set the port status to either: Open, Close or Unknown.
<b>Advanced</b>	
<b>WAN Link Status</b>	Set the WAN Link Status to either: Not configured, Link-up, Link-down or Link-test.
<b>WAN Downlink Speed</b>	Set Download speed.
<b>WAN Uplink Speed</b>	Set Upload speed.
<b>GAS Fragmentation Limit</b>	Set GAS fragmentation limit. Default is 1400.
<b>GAS Comeback Delay</b>	Set GAS comeback delay. Default is 0.





### Disable Downstream Group-Addressed Forwarding

When this option is disabled, it means the DGAF is enabled, the AP will forward all downlink broadcast ARP messages and wireless group broadcasts.

When this option is enabled, the DGAF function is disabled, the AP will discard all downlink broadcast ARP messages and wireless group broadcasts.

Disable DGAF function to prevent attackers from using the vulnerability of all clients in the same BSS using the same Group Temporal Key (GTK) to forge Group address frames and then attack the clients.

## SNMP

This section lists the SNMP options available to integrate the GWN76xx with monitoring systems

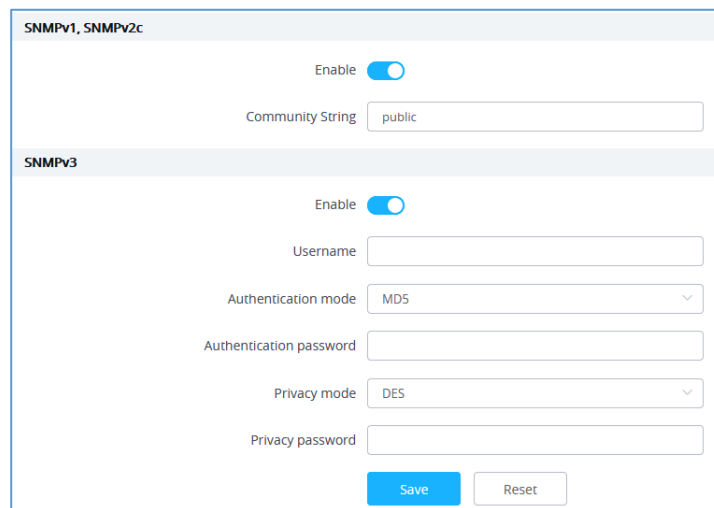


Figure 86: SNMP

Table 30: SNMP

Field	Description
Enable	Enable SNMPv1/SNMPv2c.
Community String	Enter the SNMP Community string.
Enable	Enable SNMPv3.
Username	Enter the SNMPv3 authentication username.
Authentication Mode	Set the authentication mode to: either MD5 or SHA.
Authentication password	Enter the SNMPv3 authentication password.
Privacy Mode	Set the authentication mode to: either AES128 or DES.
Privacy password	Enter the privacy password.

## DHCP Server

By default, GWN has DHCP relay, but users could create and manage multiple DHCP server pools which will be mapped to the SSID using VLAN tag, for example when creating a DHCP pool under “**System Settings** → **DHCP Server**” users need to set a VLAN ID and same one should be set under SSID to map the configured DHCP pool with the SSID. This way users could configure multiple SSIDs mapped to multiple VLANs on the network in which case they are isolated by layer 2 switching.

The table below summarizes the configuration parameters for DHCP server.

Table 31: DHCP Server Parameters

Field	Description
<b>Name</b>	Set the name of the DHCP Pool.
<b>Enable</b>	Enable/Disable the DHCP pool.
<b>VLAN ID</b>	Set a VLAN ID, same one should be set on SSID settings to map it with the DHCP pool.
<b>DHCP Server Static Address</b>	Configure the static address of the DHCP server (through which GWN Master AP will be accessible).
<b>DHCP Server Subnet Mask</b>	Sets the subnet mask for the DHCP Pool.
<b>DHCP Start Address</b>	Set the start address for DHCP
<b>DHCP End Address</b>	Set the end address for DHCP
<b>DHCP Lease Time</b>	Set the DHCP lease time for the clients (default 12h).
<b>DHCP Options</b>	Add the Option items for DHCP, detailed option contents can be found via: <a href="https://wiki.openwrt.org/doc/howto/dhcp.dnsmasq">https://wiki.openwrt.org/doc/howto/dhcp.dnsmasq</a>
<b>DHCP Gateway</b>	Set the gateway for DHCP, and it is better to set the gateway, should be different that the static IP of the access point and on the same subnet.
<b>DHCP Preferred DNS</b>	Set the preferred DNS for DHCP
<b>DHCP Alternated DNS</b>	Set the alternated DNS for DHCP

## NAT Pool

GWN76xx NAT feature defines an address pool from which the Wi-Fi clients will acquire their IP address so that the access point acts as a lightweight home router.

### Notes:



- This option cannot be enabled when **Client IP Assignment** is set to *Bridge mode*
- This option is not supported in GWN7610


**Table 32: NAT Pool Parameters**

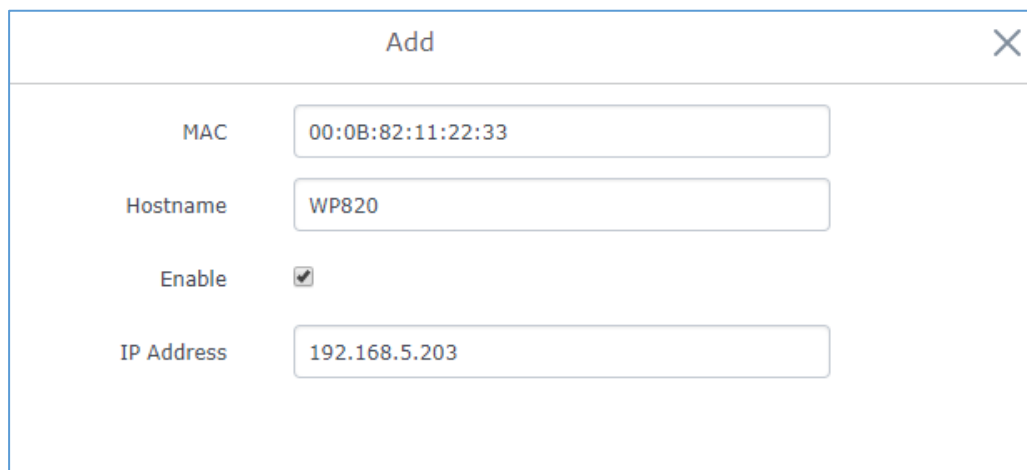
Field	Description
<b>Default Gateway</b>	Set the gateway IP address. <b>Note:</b> The gateway address cannot be in the same network segment as the uplink network.
<b>DHCP Server Subnet Mask</b>	Set the gateway mask.
<b>DHCP Lease Time</b>	Set the DHCP Lease time.
<b>DHCP Preferred DNS</b>	Set the preferred DNS for DHCP
<b>DHCP Alternate DNS</b>	Set the alternated DNS for DHCP

## Static DHCP

Users can use the feature in order to set static DHCP binding to certain clients, to whom you do not want the IP address to change.

To configure Static DHCP, please follow below steps:

1. Click  button to create a new entry.
2. Enter the name of the device, along with its MAC address and IP address



The screenshot shows a modal dialog box titled "Add" with a close button (X) in the top right corner. It contains four input fields:

- MAC:** 00:0B:82:11:22:33
- Hostname:** WP820
- Enable:**
- IP Address:** 192.168.5.203

**Figure 87: DHCP Binding**

3. Press Save and Apply to submit the changes.

## SYSTEM

### Settings

Users can access Maintenance page from GWN76XX **WebGUI**→**System** → **Settings**.

#### LEDs

GWN76XX Access Points series support also the LED schedule feature. This feature is used to set the timing when the LEDs are ON and when they will go OFF at customer's convenience.

This can be useful for example when the LEDs become disturbing during some periods of the day, this way with the LED scheduler, you can set the timing so that the LEDs are off at night after specific hours and maintain the Wi-Fi service for other clients without shutting down the AP.

Following options are available:

Table 33: LEDs

Field	Description
LEDs Always Off	Configure whether to disable the AP LED dictator
LEDs Always On	Configure whether to enable the AP LED dictator
Schedule	Please choose a schedule to assign to LEDs, users can configure schedules under the menu S

Following example on the next page sets the LEDs to be turned on from 8am till 8pm every day.

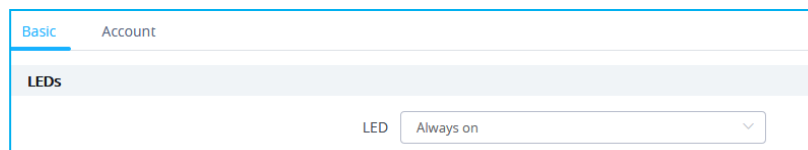


Figure 88: LED Scheduling Sample

#### Basic

Basic page allows Country and Time configuration.

Table 34: Basic

Field	Description
LED	This feature is an enhancement in regards of optimizing and reducing energy consumption of the AP. User can select to either <b>Always on</b> / <b>Always off</b> or to <b>Schedule</b> the period where the LEDs can remain on.

<b>Rebind Protection</b>	Anti-domain name hijacking protection. If enabled, when the address returned by the superior DNS is a private LAN address, it will be regarded as a domain name hijacking, thus discarding the analytical result. If disabled, the analytical results will not be discarded.
<b>Legacy TLS Compatibility</b>	Due to the security enhancement, unless Legacy TLS Compatibility (only available on 1.0.15.4 or higher version) is enabled, master AP on 1.0.15.4 or higher firmware will not compatible with slave AP on firmware lower than 1.0.15.4. Master AP on firmware lower than 1.0.15.4 will also not be compatible with slave AP on firmware 1.0.15.4 or higher. Cloud and GWN Manager will still support both firmwares. Default is enabled.
<b>Web HTTP Access</b>	Enables Web HTTP Access. By default, it's disabled.
<b>Web HTTPS Port</b>	Specifies HTTPS port. By default, is 443.
<b>Country</b>	Select the country from the drop-down list. This can affect the number of channels depending on the country standards.
<b>Scene</b>	Depending deployment type (Indoor or Outdoor) then additional 5Ghz channels (DFS Channels) will be available to be used. Please refer to table <b>DFS Channels supported by Model</b> .
<b>Time Zone</b>	Configure time zone for the GWN76XX. Make sure to reboot the device to take effect.
<b>NTP Server</b>	Configure the IP address or URL of the NTP server. The device will obtain the date and time from the configured server.
<b>Date Display Format</b>	Change the Date Display Format, three options are possible YYYY/MM/DD, MM/DD/YYYY and DD/MM/YYYY.
<b>Reboot Schedule</b>	Select the time schedule when AP will be rebooted. Refer to [S] to define time.
<b>Hardware Reset</b>	Once disabled, the hardware reset button on AP will be ineffective. Factory reset may only be triggered from software layer.

**Table 35: DFS Channels supported by Model**

1.0.19.4	CE	RCM	FCC	IC	ANATEL(Brazil)
GWN7610	N/A	N/A	N/A	N/A	N/A
GWN7660	N/A	N/A	N/A	N/A	N/A
GWN7600	N/A	N/A	N/A	N/A	Yes
GWN7600LR	Yes	N/A	N/A	N/A	N/A



GWN7630	Yes	Yes	Yes	Yes	Yes
GWN7630LR	Yes	Yes	Yes	Yes	N/A
GWN7602	Yes	Yes	Yes	Yes	Yes
GWN7605	Yes	Yes	Yes	Yes	N/A
GWN7605LR	Yes	Yes	Yes	Yes	N/A
GWN7615	Yes	Yes	Yes	Yes	N/A

## Account

The Access Web page provide configuration for admin and user password.

Table 36: Account

Field	Description
<b>Current Administrator Password</b>	Enter the current administrator password
<b>New Administrator Password</b>	Change the current password. This field is case sensitive with a maximum length of 32 characters.
<b>Confirm New Administrator Password</b>	Enter the new administrator password one more time to confirm.
<b>New User Password</b>	Configure the password for user-level Web GUI access. This field is case sensitive with a maximum length of 32 characters.
<b>Confirm New User Password</b>	Enter the new User password again to confirm.

**Note:** User passwords registered for authentication through the web portal are stored in an encrypted form.

## Mesh

In Mesh Network, wireless connection is established between multiple Aps, which is used to pass-through data traffic rather than client association. Each AP will evaluate the performance of wireless channel based on several factors and choose one or multiple appropriate APs to setup connection.

In a mesh network, access points are categorized to two types:

- **CAP (Central Access Point):** this is an access point that has an uplink connection to the wired network.



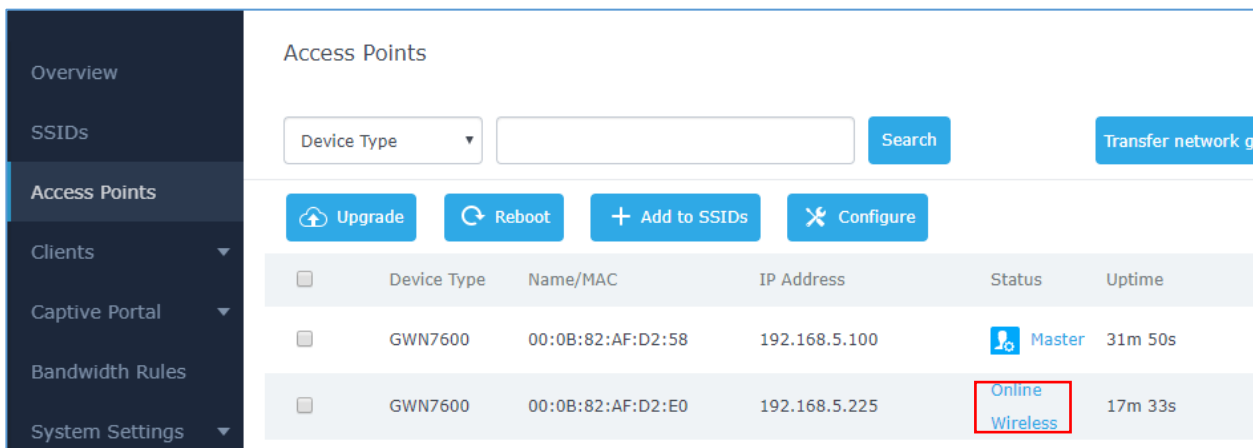
- **RE (Range Extender):** This is an access point that participate on the mesh network topology and has a wireless uplink connection to the central network.

In order to deploy mesh access points (RE), users/installers can follow below steps:

1. Make sure to have the master and CAP access points already deployed (sometimes the CAP access points can be the master controller of the network).
2. Next, we need to pair the RE access points to the master. This can be done in two ways:
  - A. Connect all REs to the same wired LAN as the master then perform the normal process of discovery/pairing process, and after successfully pairing the APs they can be deployed on the field.
  - B. REs can also be discovered wirelessly when powered via PSU or PoE Injector, and admin can configure them after discovery. This requires that the REs must be within the range of the Master or CAP Slave's signals coverage.

**Note:** If there are other GWN APs broadcasting in the same field with different subnet, RE may be wirelessly connected to those networks and cannot be discovered and paired by your Master. Therefore, it is recommended to use the first method of wired pairing and then deploy those REs.

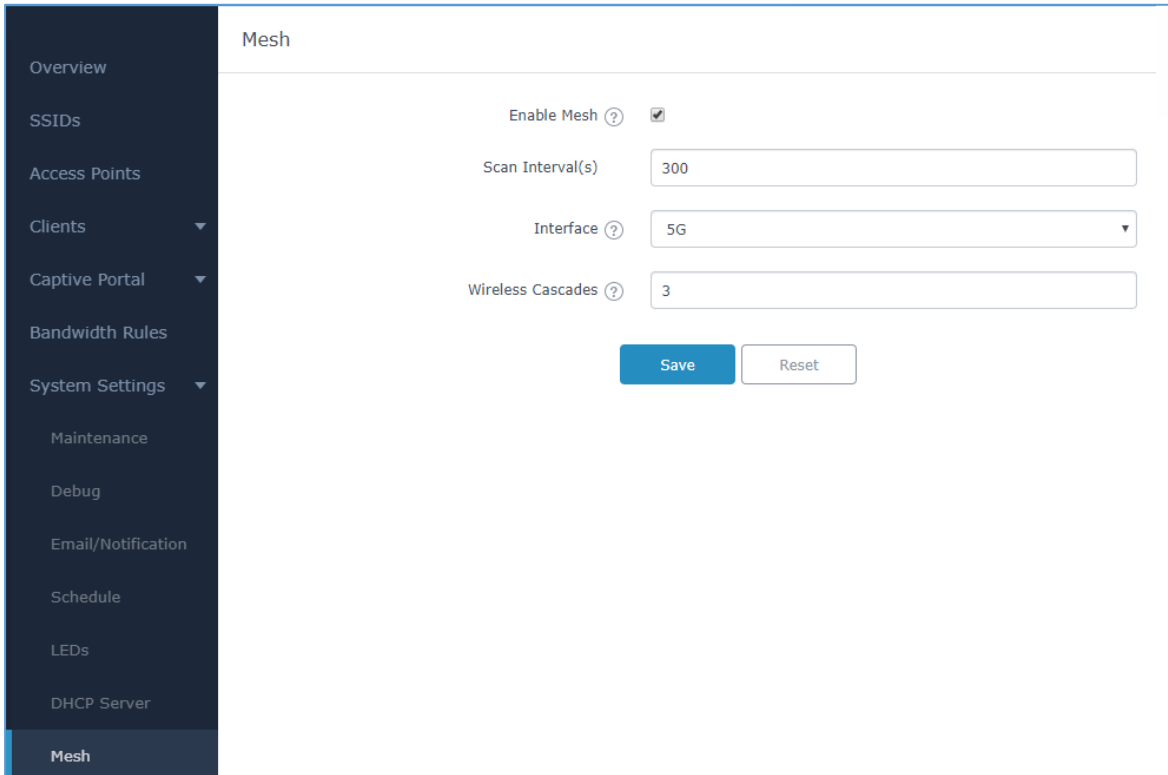
3. After that all slave access points have been deployed and paired to the master, you can directly manage them to operate the mesh network. Mesh service configuration is the same as transitional GWN WLAN.
4. Log into the master page, and under Access Points page you can see the information, for example the AP in the **“Online Wireless”** state is the RE (Range Extender) with a wireless uplink to the CAP. The APs showing **“Online”** state are either a wired **master** or **CAP**.



Device Type	Name/MAC	IP Address	Status	Uptime
GWN7600	00:0B:82:AF:D2:58	192.168.5.100	Master	31m 50s
GWN7600	00:0B:82:AF:D2:E0	192.168.5.225	Online Wireless	17m 33s

**Figure 89: Access Points Status**

For Global mesh network settings, on GWN76XX, navigate to the menu **“System → Settings → Mesh”** for setting up the following parameters described below:



**Figure 90: Mesh settings for GWN76XX**

The following table down below describes the Mesh configuration settings for the GWN76XX:

**Table 37: Mesh configuration on GWN76XX**

Filed	Description
<b>Enable Mesh</b>	When checked the Mesh feature will be activated. Default is disabled.
<b>Scan Interval</b>	Interval in seconds to scan for available Mesh neighbors. Must be less than or equal to 300 seconds.
<b>Interface</b>	Select either 2.4GHz or 5GHz band.
<b>Wireless Cascades</b>	Define how many AP can be cascaded wirelessly with the AP. The minimum value is 1 and maximum value is 3.

For more detailed information about GWN Mesh network feature, you may refer to the following technical document: [Mesh Network Guide](#).

**Important Notes:**

- The RE should be set with DHCP Mode for a Client device connected to NET PORT to acquire an IP Address.
- If RE is set with static IP, then using a PoE injector is recommended as any Network activity detected by the AP will cause the Mesh to fail. Otherwise user will only need to make sure that there is no DHCP Server in the network connected to the AP's Ethernet port.



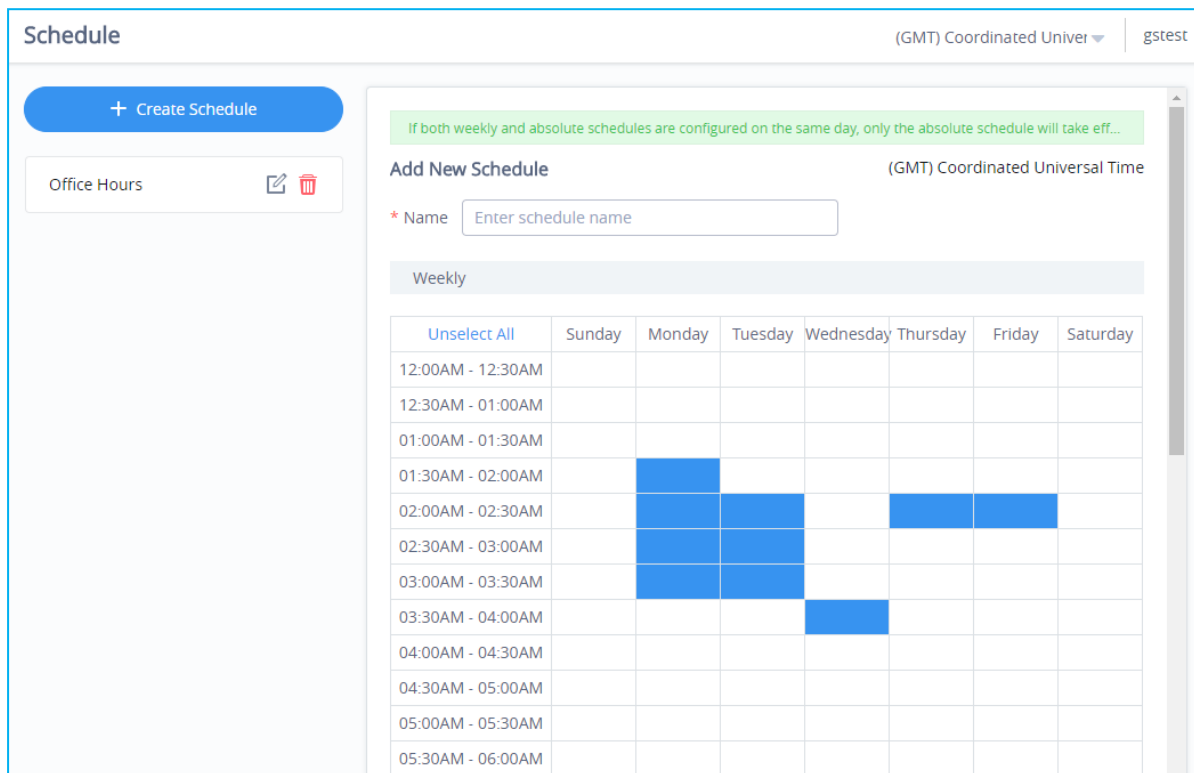
## Schedule

Users can use the schedule configuration menu to set specific schedule for GWN features while giving the flexibility to specify the date and time to turn ON/OFF the selected feature.

The Schedule can be used for settings up specific time for Wi-Fi where the service will be active or for LED schedule or bandwidth rules ...etc.

To configure a new schedule, follow below steps:

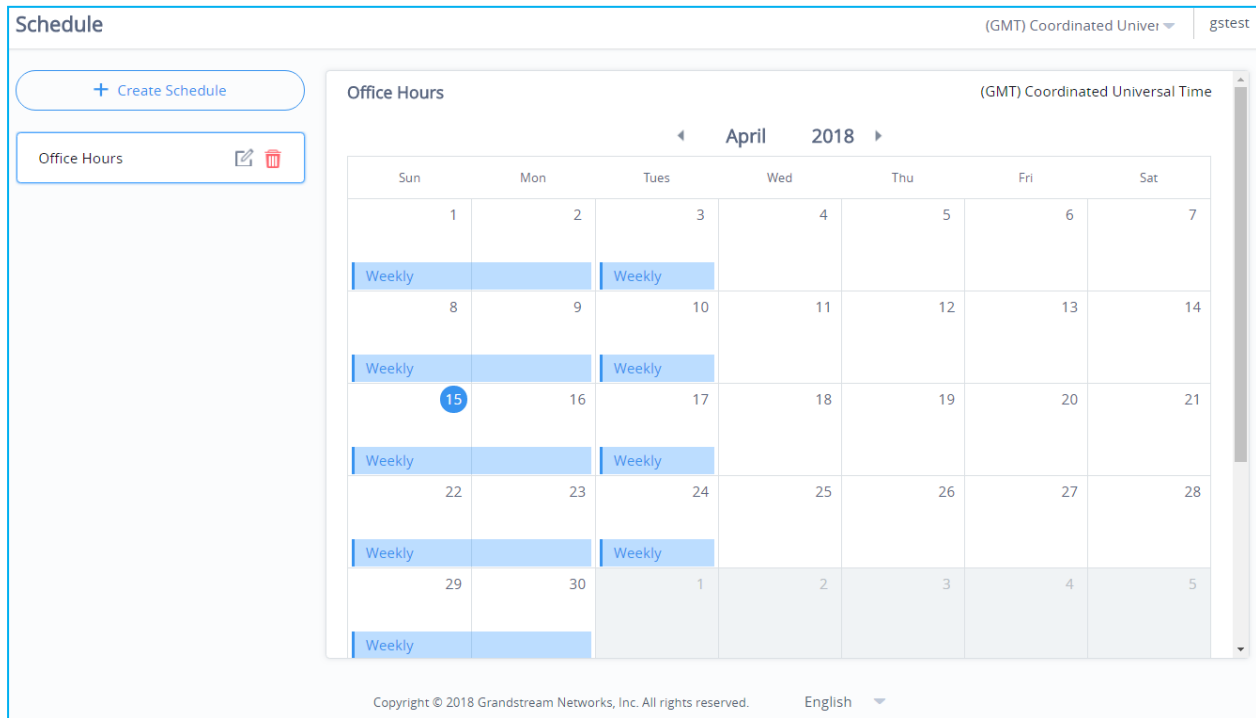
1. Go under **System** → **Schedule** and click on **Create New Schedule**.



**Figure 91: Create New Schedule**

2. Select the periods on each day that will be included on the schedule and enter a name for the schedule (ex: office hours).
3. Users can choose to set weekly schedule or absolute schedule (for specific days for example), and if both weekly schedule and absolute schedules are configured on the same day then the absolute schedule will take effect and the weekly program will be cancelled for that specific date.
4. Once the schedule periods are selected, click on **Save** to save the schedule.

The list of created schedules will be displayed as shown on the figure below. With the possibility to edit or delete each schedule:



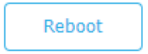
**Figure 92: Schedules List**


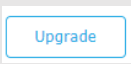
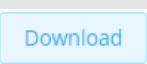
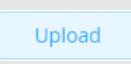
## Maintenance

### Upgrade

The Upgrade Web page allows upgrade related configuration.

**Table 38: Upgrade**

Field	Description
<b>Upgrade Protocol</b>	Allow users to choose the method to load the firmware and config: TFTP, HTTP or HTTPS.
<b>Allow DHCP options 66 and 43 override</b>	Enable/Disable DHCP options 66 and 43 to override the upgrade and provisioning settings
<b>Check/Download New Firmware and Config at Boot</b>	Configure whether to enable/disable automatic upgrade and provisioning when reboot.
<b>Reboot</b>	Click on  button to reboot device.

<b>Factory Reset</b>	Click on  to restore the device and all online APs to factory default settings.
<b>Firmware Server</b>	Define the IP address or URL for the firmware upgrade server. Make sure all files relevant to the firmware are updated completely.
<b>Upgrade Now</b>	Click on  button to begin the upgrade. Note that the device will reboot after downloading the firmware.
<b>Automatic Upgrade</b>	Set automatic upgrade every intervals/day/week. The device will request to upgrade automatically according to the setup time. The default setting is Disabled
<b>X Hours</b>	Select the time period to check for firmware upgrade. <i>This field is available when select "Check every X Hours" in "Automatic Upgrade"</i>
<b>Hour of Day (0-23)</b>	Defines the hour of the day (0-23) to check the HTTP/TFTP server for firmware upgrade or configuration file changes. <i>This field is available when select "Check at Hour of Day" and "Check at Day of Week" in "Automatic Upgrade"</i>
<b>Day of Week</b>	Defines the day of the week to check the HTTP/TFTP server for firmware upgrade or configuration file changes. <i>This field is available when select "Check at Day of Week" in "Automatic Upgrade"</i>
<b>Config Server</b>	Configures the IP address or URL for the file server. It might be different from the firmware upgrade server.
<b>Authenticate Config File</b>	Authenticates configuration file before acceptance. The default setting is No.
<b>XML Config File Password</b>	The password for encrypting the XML configuration file using OpenSSL. The password is to decrypt the XML configuration file if it is encrypted via OpenSSL.
<b>Download Configuration</b>	Click on  button to download the device configuration file to PC.
<b>Upload Configuration</b>	Click on  to select a compressed config file to restore the config; after succeeding, the device will reboot automatically.



## Syslog

The syslog Web page provides configuration settings for syslog.

Table 39: Syslog Parameters

Field	Description
Syslog Server	Enter the IP address or URL of Syslog server.
Syslog Level	Select the level of Syslog, 5 levels are available: <b>None, Debug, Info, Warning</b> and <b>Error</b> .
Log DNS Queries	Check to log DNS Queries.

## Alert

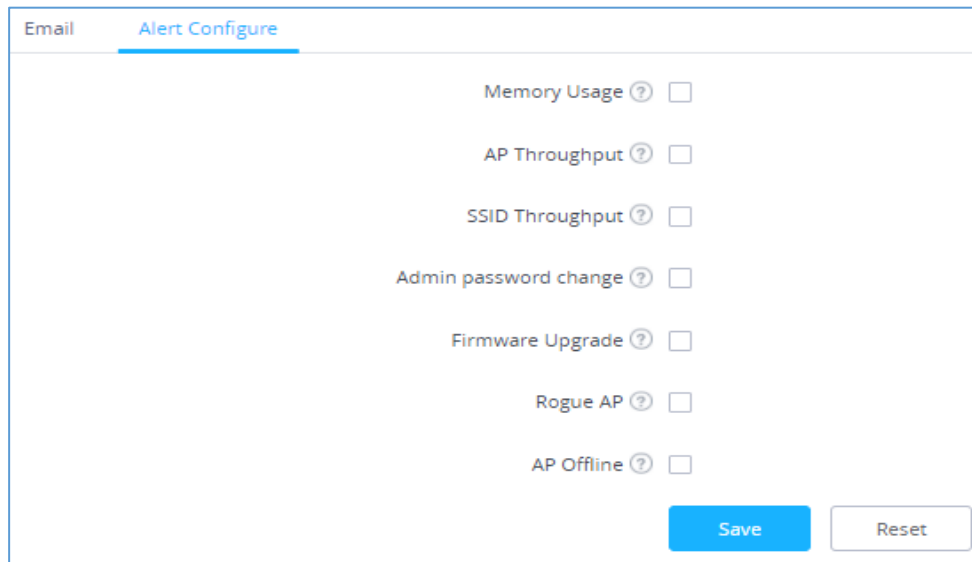
The Alert page allows the administrator to select a predefined set of system events and to send notifications upon the change of the set events via email.

## Email

Table 40: Email configuration

Field	Description
Enable Email Notification	Set whether to enable Email notification

## Alert Configure



Alert Configure

- Memory Usage ?
- AP Throughput ?
- SSID Throughput ?
- Admin password change ?
- Firmware Upgrade ?
- Rogue AP ?
- AP Offline ?

Save Reset

Figure 93: Alert Configure

The following table describes the notifications configuration settings.

**Table 41: Email Events**

Filed	Description
<b>Memory Usage</b>	Configures whether to send notification if memory usage is greater than the configured threshold.
<b>AP Throughput</b>	Once enabled, master will generate an Alert when AP throughput reaches the configured threshold.
<b>SSID Throughput</b>	Once enabled, master will generate an Alert when SSID throughput reaches the configured threshold.
<b>Admin Password Change</b>	Configures whether to send notification on admin password change.
<b>Firmware upgrade</b>	Configures whether to send notification on firmware upgrade.
<b>Rogue AP</b>	Once enabled, system will generate an Alert when there is a Rogue AP detected.
<b>AP Offline</b>	Configures whether to send notification when AP going offline.

## UPGRADING AND PROVISIONING

### Upgrading Firmware

The GWN76XX can be upgraded to a new firmware version remotely or locally. This section describes how to upgrade your GWN76XX.

#### Upgrading via Web GUI

The GWN76XX can be upgraded via TFTP/HTTP/HTTPS by configuring the URL/IP Address for the TFTP/HTTP/HTTPS server and selecting a download method. Configure a valid URL for TFTP, HTTP or HTTPS; the server name can be FQDN or IP address.

#### Examples of valid URLs:

firmware.grandstream.com/BETA

192.168.5.87



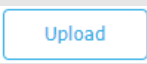


The upgrading configuration can be accessed via:

**Web GUI→System Settings→Maintenance→Upgrade**

Table 42: Network Upgrade Configuration

Field	Description
<b>Authenticate Config File</b>	Authenticates configuration file before acceptance. The default setting is No.
<b>XML Config File Password</b>	The password for encrypting the XML configuration file using OpenSSL. The password is to decrypt the XML configuration file is it is encrypted via OpenSSL
<b>Upgrade Via</b>	Allow users to choose the method to load the firmware and config: TFTP, HTTP or HTTPS.
<b>Firmware Server</b>	Define the IP address or URL for the firmware upgrade server. Make sure all files relevant to the firmware are updated completely
<b>Config Server</b>	Configure the IP address of URL for the file server.
<b>Check/Download New Firmware and Config at Boot</b>	Configure whether to enable/disable automatic upgrade and provisioning when reboot.
<b>Allow DHCP options 66 and 43 override</b>	Enable/Disable DHCP options 66 and 43 to override the upgrade and provisioning settings.



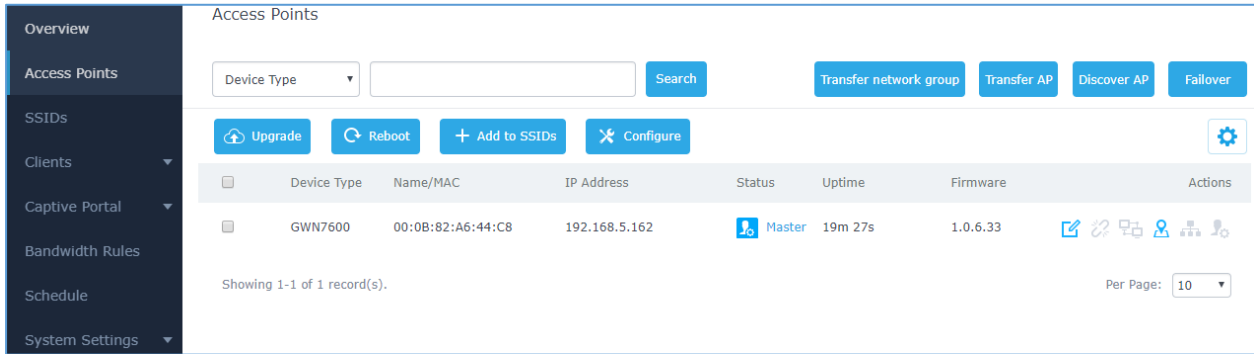
<b>Automatic Upgrade</b>	Set automatic upgrade every intervals/day/week. The device will request to upgrade automatically according to the setup time. The default setting is Disabled
<b>X Hours</b>	Select the time period to check for firmware upgrade. <i>This field is available when select "Check every X Hours" in "Automatic Upgrade"</i>
<b>Hour of Day (0-23)</b>	Defines the hour of the day (0-23) to check the HTTP/TFTP server for firmware upgrade or configuration file changes. <i>This field is available when select "Check at Hour of Day" and "Check at Day of Week" in "Automatic Upgrade"</i>
<b>Day of Week</b>	Defines the day of the week to check the HTTP/TFTP server for firmware upgrade or configuration file changes. <i>This field is available when select "Check at Day of Week" in "Automatic Upgrade"</i>
<b>Upgrade Now</b>	Click on  button to begin the upgrade. Note that the device will reboot after downloading the firmware. Note: Please save and apply your configuration first if there are any configuration modification.
<b>Download Configuration</b>	Click on  button to download the device configuration file to PC.
<b>Upload Configuration</b>	Click on  to select a compressed config file to restore the config; after succeeding, the device will reboot automatically.
<b>Reboot</b>	Click on  button to reboot device.
<b>Factory Reset</b>	Click on  to restore the device and all online APs to factory default settings.

## Upgrading Slave Access Points


When the GWN76XX is being paired as slave using another GWN76XX Access Point acting as Controller, users can upgrade their paired access points from the GWN76XX Master Controller.

To upgrade a slave access point, log in to the GWN76XX acting as Master Controller and go to **Access Points**.





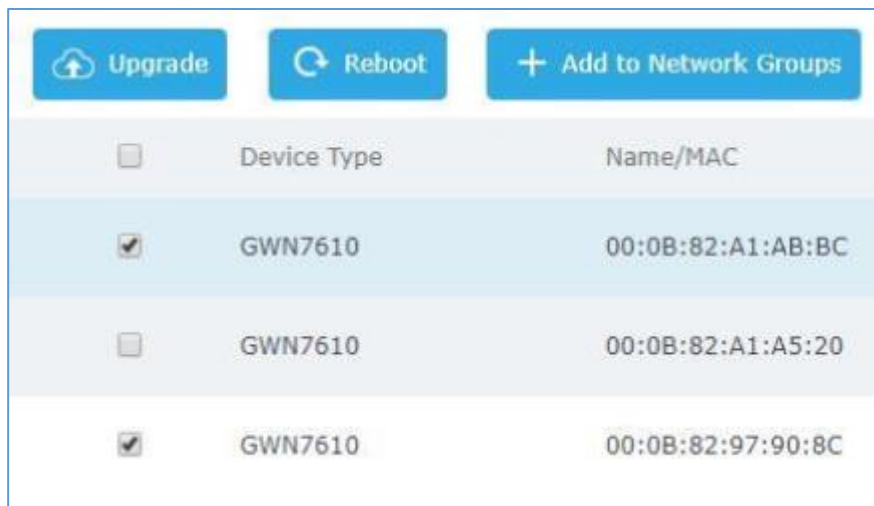
**Figure 94: Access Points**

Make sure that firmware server path is set correctly under Maintenance, check the desired APs to upgrade, and click on  to upgrade the selected paired access points.

### Sequential Upgrade

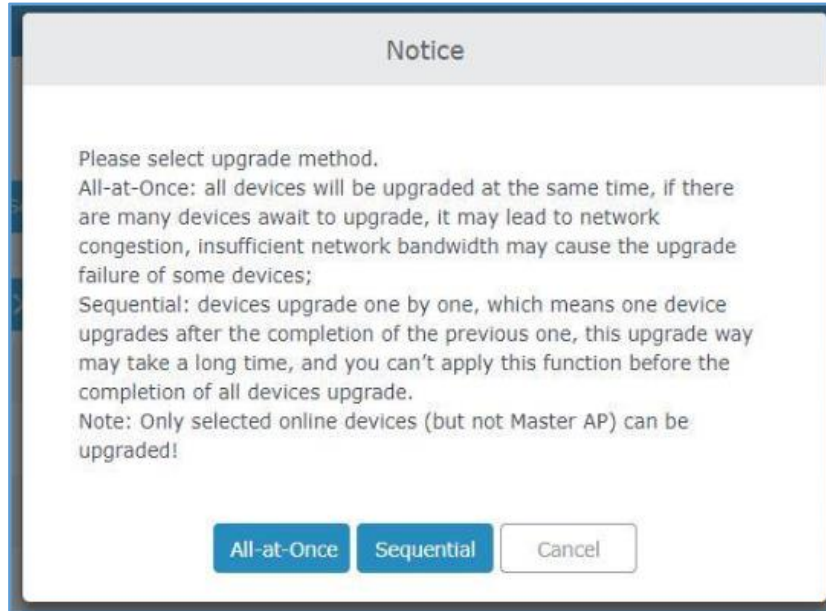
If you choose multiple slave devices to upgrade their firmware, two options are available: “All-at-Once” and “Sequential”. “All-at-Once” will use the default method, all checked slaves will upgrade their firmware at the same time, while using “Sequential” upgrade method, the slaves will upgrade their firmware one by one in order to:

- Avoid entire Wi-Fi service interruption by full system firmware upgrade.
- Reduce network bandwidth consumption caused by firmware downloading.

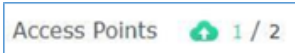


**Figure 95: Choosing multiple devices**





**Figure 96: All-at-Once and Sequential Upgrade**

Once you choose sequential upgrade, the following icon  will update you about the number of upgraded slaves out of the selected slaves.

## Provisioning and Backup

The GWN76XX configuration can be backed up locally or via network. The backup file will be used to restore the configuration on GWN76XX when necessary.


### Download Configuration

Users can download the GWN76XX configuration for restore purpose under **Web GUI→System Settings→Maintenance→Upgrade**.

Click on  to download locally the configuration file.

### Upload Configuration

Users can upload configuration file to the GWN76XX under **Web GUI→System Settings→Maintenance→Upgrade**.



Click on  to browse for the configuration to upload.

Please note that the GWN76XX will reboot after the configuration file is restored successfully.

## Configuration Server

Users can download and provision the GWN76XX by putting the config file on a TFTP/HTTP or HTTPS server and set Config Server to the TFTP/HTTP or HTTPS server used in order for the GWN76XX to be provisioned with that config server file.

## Reset and reboot

- Users could perform a reboot and reset the device to factory functions under **Web GUI**→**System Settings**→**Maintenance**→**Upgrade** by clicking on  button.
-  Will restore all the GWN76XX itself to factory settings.

## Syslog

On the GWN76XX, users could dump the syslog information to a remote server under **Web GUI**→**System Settings**→**Maintenance**. Enter the syslog server hostname or IP address and select the level for the syslog information. Five levels of syslog are available: None, Debug, Info, Warning, and Error.



## EXPERIENCING THE GWN76XX Wi-Fi ACCESS POINTS

Please visit our website: <http://www.grandstream.com> to receive the most up- to-date updates on firmware releases, additional features, FAQs, documentation and news on new products.

We encourage you to browse our [product related documentation](#), [FAQs](#) and [User and Developer Forum](#) for answers to your general questions. If you have purchased our products through a Grandstream Certified Partner or Reseller, please contact them directly for immediate support.

Our technical support staff is trained and ready to answer all your questions. Contact a technical support member or [submit a trouble ticket online](#) to receive in-depth support.

Thank you again for purchasing Grandstream GWN76XX Wi-Fi Access Point, it will be sure to bring convenience and color to both your business and personal life

